



UCBD20120A

SiC-SBD DIODE

SILICON CARBIDE SCHOTTKY BARRIER DIODES

DESCRIPTION

The **UCBD20120A** is an SiC Schottky barrier diodes (SBDs) feature high reverse voltage ratings. In addition to SBDs with short reverse recovery time (t_{rr}), provides 1200V SBDs with a junction barrier Schottky (JBS) structure that provide low leakage current (I_r) and high surge current capability required for switched-mode power supplies. These devices help improve the efficiency of switched-mode power supplies.

FEATURES

- * Zero Forward/Reverse Recovery Current
- * High Blocking Voltage
- * High Frequency Operation
- * Positive Temperature Coefficient on V_F
- * Temperature Independent Switching Behavior
- * High surge current capability

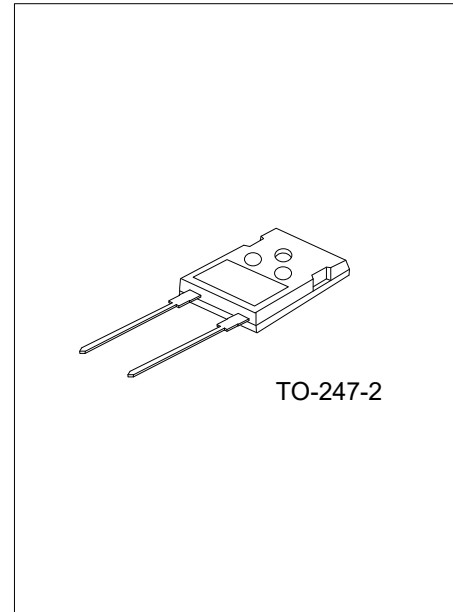

SYMBOL

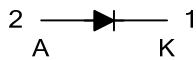

ORDERING INFORMATION

Ordering Number		Package	Pin Assignment		Packing
Lead Free	Halogen Free		1	2	
UCBD20120AL-T472-T	UCBD20120AG-T472-T	TO-247-2	K	A	Tube

Note: Pin Assignment: K: Cathode A: Anode

<p>UCBD20120AG-T472-T</p> <p>(1) Packing Type</p> <p>(2) Package Type</p> <p>(3) Green Package</p>	<p>(1) T: Tube</p> <p>(2) T472: TO-247-2</p> <p>(3) G: Halogen Free and Lead Free, L: Lead Free</p>
--	---

MARKING

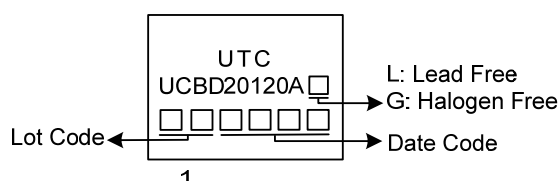

■ ABSOLUTE MAXIMUM RATINGS ($T_C=25^\circ\text{C}$, unless otherwise specified)

Ratings at 25°C ambient temperature unless otherwise specified. Resistive or inductive load, 60Hz.

PARAMETER		SYMBOL	RATINGS	UNIT
Repetitive Peak Reverse Voltage		V_{RRM}	1200	V
Surge Peak Reverse Voltage		V_{RSM}	1200	V
DC Blocking Voltage		V_R	1200	V
Continuous Forward Current	$T_C=150^\circ\text{C}$	I_F	20	A
Repetitive Peak Forward Surge Current	$T_J=25^\circ\text{C}$ $t_p=10\text{ms}$, Half Sine Wave	I_{FRM}	145	A
	$T_J=110^\circ\text{C}$ $t_p=10\text{ms}$, Half Sine Wave		130	A
Non-Repetitive Peak Forward Surge Current	$T_J=25^\circ\text{C}$ $t_p=10\text{ms}$, Half Sine Wave	I_{FSM}	160	A
	$T_J=110^\circ\text{C}$ $t_p=10\text{ms}$, Half Sine Wave		150	A
Operating Junction Temperature		T_J	-55 ~ +175	$^\circ\text{C}$
Storage Temperature Range		T_{STG}	-55 ~ +175	$^\circ\text{C}$

Note: Absolute maximum ratings are those values beyond which the device could be permanently damaged. Absolute maximum ratings are stress ratings only and functional device operation is not implied.

■ ELECTRICAL CHARACTERISTICS

(Ratings at 25°C ambient temperature unless otherwise specified. Resistive or inductive load, 60Hz)

PARAMETER	SYMBOL	TEST CONDITIONS	MIN	TYP	MAX	UNIT
DC Blocking Voltage	V_{DC}	$T_C=25^\circ\text{C}$	1200			V
Forward Voltage	V_F	$I_F=20\text{A}$, $T_J=25^\circ\text{C}$		1.35	1.7	V
		$I_F=20\text{A}$, $T_J=125^\circ\text{C}$		1.6		V
		$I_F=20\text{A}$, $T_J=175^\circ\text{C}$		1.85		V
Reverse Current	I_R	$V_R=1200\text{V}$, $T_J=25^\circ\text{C}$		10	150	μA
		$V_R=1200\text{V}$, $T_J=125^\circ\text{C}$		45		μA
		$V_R=1200\text{V}$, $T_J=175^\circ\text{C}$		130		μA
Total Capacitive Charge	Q_C	$V_R=800\text{V}$, $T_J=25^\circ\text{C}$		105		nC
Total Capacitance	C	$V_R=1.0\text{V}$, $T_J=25^\circ\text{C}$, $f=1\text{MHz}$		1200		pF
		$V_R=400\text{V}$, $T_J=25^\circ\text{C}$, $f=1\text{MHz}$		100		pF
		$V_R=800\text{V}$, $T_J=25^\circ\text{C}$, $f=1\text{MHz}$		70		pF

■ TYPICAL CHARACTERISTICS

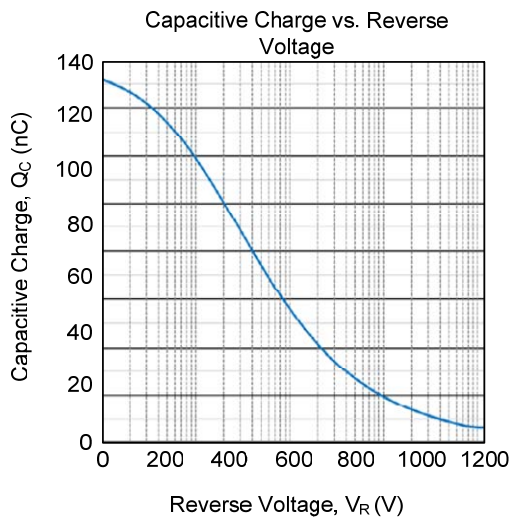
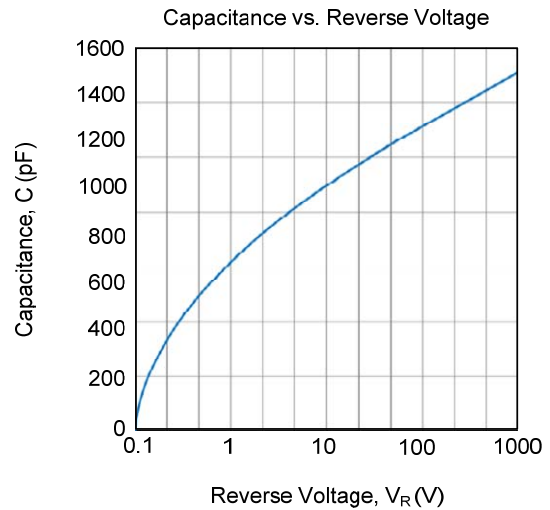
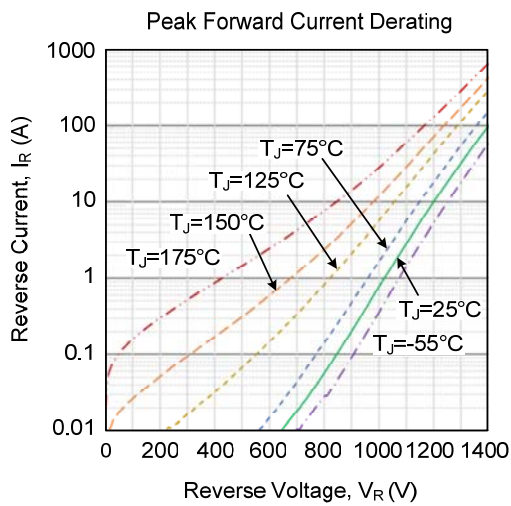
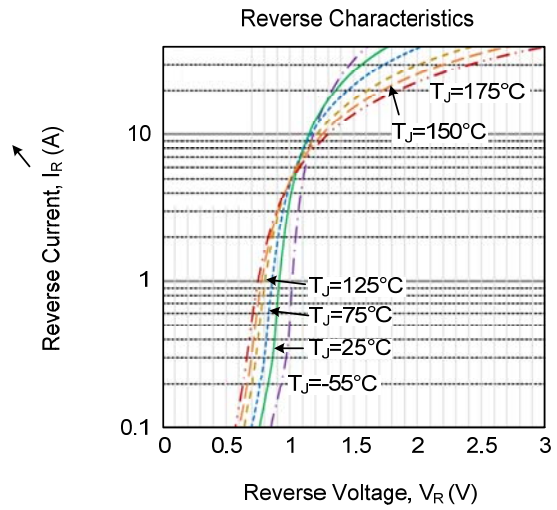
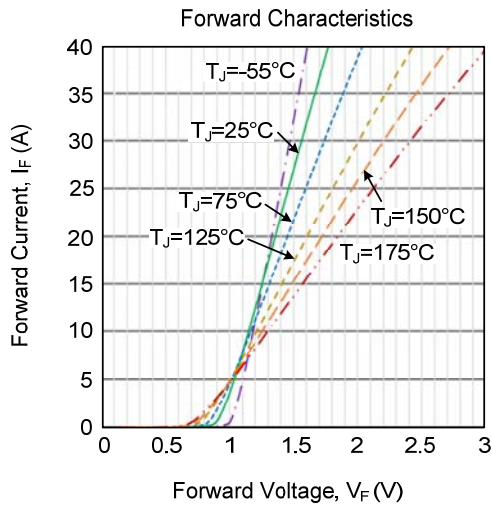

UTC assumes no responsibility for equipment failures that result from using products at values that exceed, even momentarily, rated values (such as maximum ratings, operating condition ranges, or other parameters) listed in products specifications of any and all UTC products described or contained herein. UTC products are not designed for use in life support appliances, devices or systems where malfunction of these products can be reasonably expected to result in personal injury. Reproduction in whole or in part is prohibited without the prior written consent of the copyright owner. UTC reserves the right to make changes to information published in this document, including without limitation specifications and product descriptions, at any time and without notice. This document supersedes and replaces all information supplied prior to the publication hereof.