



## ULN2803Q

LINEAR INTEGRATED CIRCUIT

### EIGHT DARLINGTON ARRAYS

#### DESCRIPTION

The UTC **ULN2803Q** is high-voltage, high-current Darlington drivers comprised of eight NPN Darlington pairs.

#### FEATURES

- \*Output current (single output) 500mA MAX.
- \*High sustaining voltage output 50V MIN.
- \*Output clamp diodes
- \*Inputs compatible with various types of logic

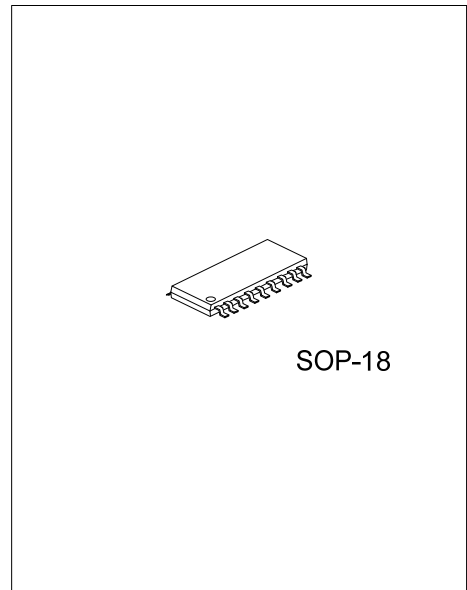

#### ORDERING INFORMATION

Ordering Number		Package	Packing
Lead Free	Halogen Free		
ULN2803QL-S18-R	ULN2803QG-S18-R	SOP-18	Tape Reel

<p>ULN2803QG-S18-R</p> <p>(1) Packing Type (2) Package Type (3) Green Package</p>	<p>(1) R: Tape Reel (2) S18: SOP-18 (3) G: Halogen Free and Lead Free, L: Lead Free</p>
---	---

#### MARKING

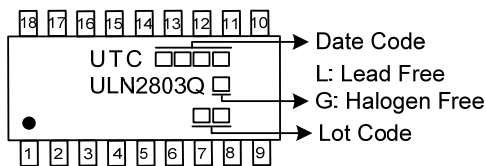

- 3
- PIN CONFIGURATIONS

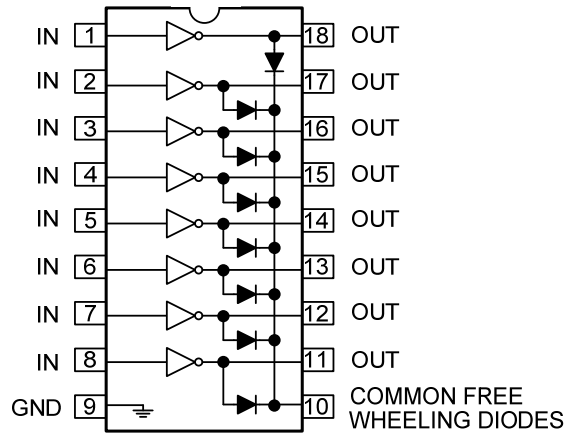

- SCHEMATICS (EACH DRIVER)

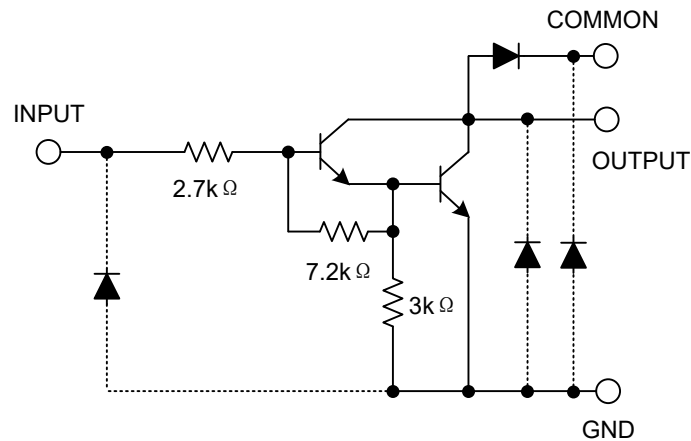

Note: The input and output parasitic diodes cannot be used as clamp diodes.

### ■ ABSOLUTE MAXIMUM RATINGS

PARAMETER	SYMBOL	RATINGS	UNIT
Input Voltage	$V_{IN}$	-0.5 ~ 30	V
Output Sustaining Voltage	$V_{CE(SUS)}$	-0.5 ~ 50	V
Output Current	$I_{OUT}$	500	mA/ch
Clamp Diode Reverse Voltage	$V_R$	50	V
Clamp Diode Forward Current	$I_F$	500	mA
Power Dissipation	$P_D$	0.92 / 1.31 (Note 2)	W
Operating Temperature	$T_{OPR}$	-40 ~ +85	°C
Storage Temperature	$T_{STG}$	-40 ~ +150	°C

Notes: 1. Absolute maximum ratings are stress ratings only and functional device operation is not implied. The device could be damaged beyond Absolute maximum ratings.

2. On glass epoxy PCB (75x144x1.6mm Cu 20%).

### ■ ELECTRICAL CHARACTERISTICS ( $T_A=25^\circ\text{C}$ , unless otherwise specified)

PARAMETER	SYMBOL	TEST CIRCUIT	TEST CONDITIONS	MIN	TYP	MAX	UNIT
Output Leakage Current	$I_{CEX}$	1	$V_{CE}=50\text{V}, T_A=25^\circ\text{C}$ $V_{CE}=50\text{V}, T_A=85^\circ\text{C}$			50 100	$\mu\text{A}$
Collector-Emitter Saturation Voltage	$V_{CE(SAT)}$	2	$I_{OUT}=350\text{mA}, I_{IN}=500\mu\text{A}$ $I_{OUT}=200\text{mA}, I_{IN}=350\mu\text{A}$ $I_{OUT}=100\text{mA}, I_{IN}=250\mu\text{A}$		1.3 1.1 0.9	1.6 1.3 1.1	V
Input Current	ON	$I_{IN(ON)}$	$V_{IN}=3.85\text{V}, I_{OUT}=350\text{mA}$		0.93	1.35	mA
	OFF	$I_{IN(OFF)}$	$I_{OUT}=500\mu\text{A}, T_A=85^\circ\text{C}$	50	65		$\mu\text{A}$
Input Voltage (output on)	$V_{IN(ON)}$	5	$V_{CE}=2.0\text{V}$ $I_{OUT}=200\text{mA}$ $I_{OUT}=250\text{mA}$ $I_{OUT}=300\text{mA}$			2.4 2.7 3.0	V
Clamp Diode Reverse Current	$I_R$	6	$V_R=50\text{V}, T_A=25^\circ\text{C}$ $V_R=50\text{V}, T_A=85^\circ\text{C}$			50 100	$\mu\text{A}$
Clamp Diode Forward Voltage	$V_F$	7	$I_F=350\text{mA}$			2.0	V
Input Capacitance	$C_{IN}$				15	25	pF
Turn-On Delay	$t_{ON}$	8	$V_{OUT}=50\text{V}, R_L=125\Omega, C_L=15\text{pF}$		0.1	1	$\mu\text{S}$
Turn-Off Delay	$t_{OFF}$	8	$V_{OUT}=50\text{V}, R_L=125\Omega, C_L=15\text{pF}$		0.2	1	$\mu\text{S}$

### ■ TEST CIRCUIT

1.  $I_{CEX}$

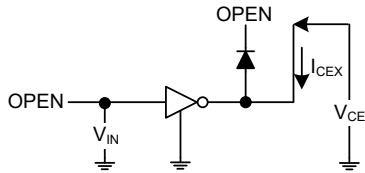

2.  $V_{CE(sat)}$ ,  $h_{FE}$

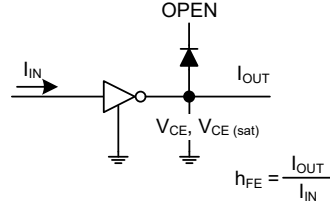

3.  $I_{IN(ON)}$

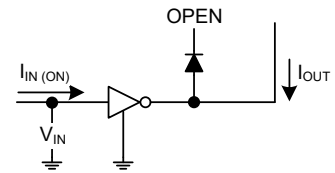

4.  $I_{IN(OFF)}$

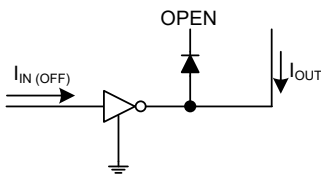

5.  $V_{IN(ON)}$

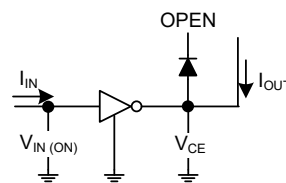

6.  $I_R$

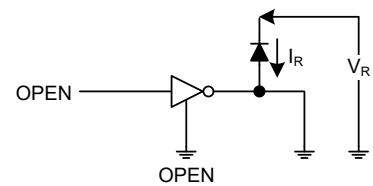

7.  $V_F$

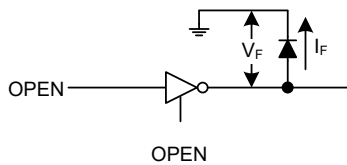

8.  $t_{ON}$ ,  $t_{OFF}$

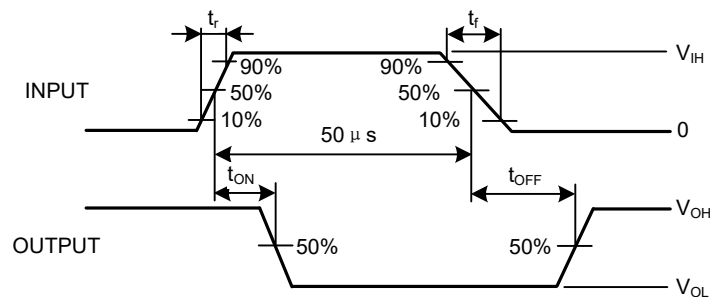
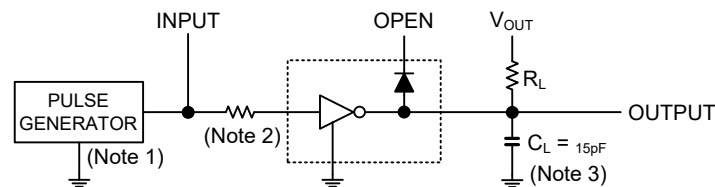

- Notes: 1. Pulse width 50μs, duty cycle 10%  
 Output impedance 50Ω,  $t_r \leq 5ns$ ,  $t_f \leq 10ns$   
 2.  $R_1: 0$ ,  $V_{IH}: 3V$   
 3.  $C_L$  includes probe and jig capacitance.

## TYPICAL CHARACTERISTICS

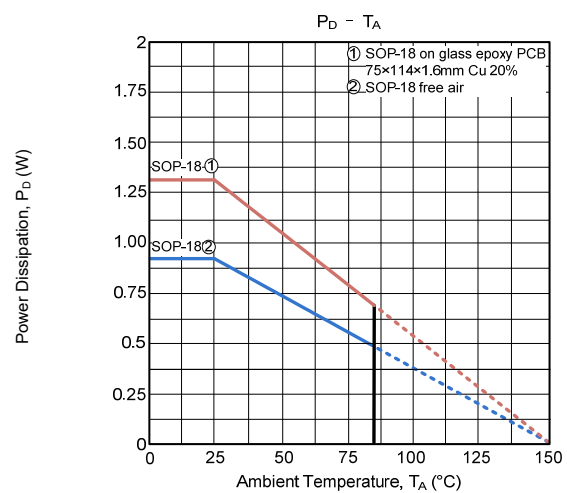
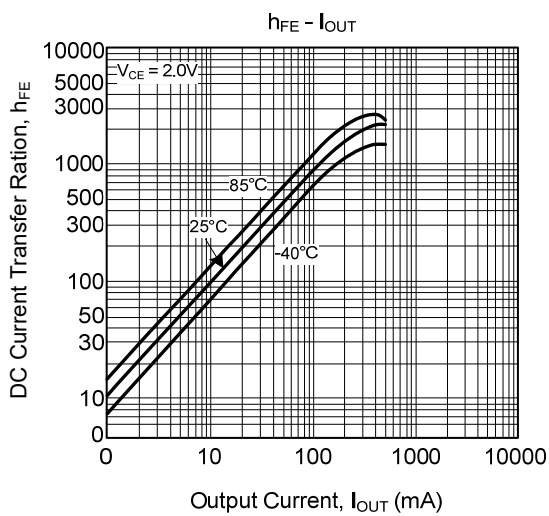
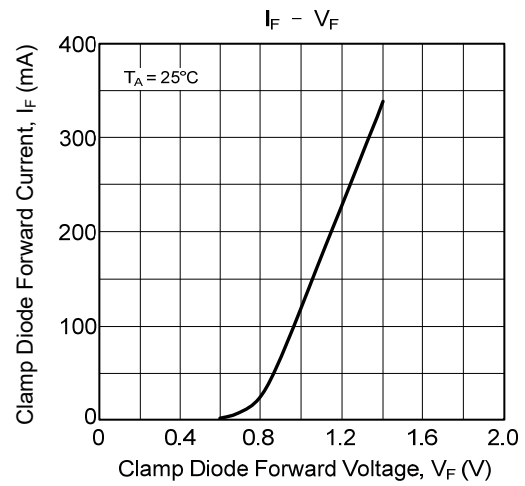
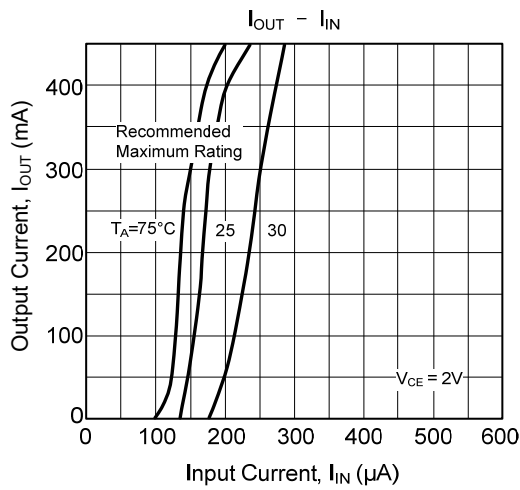
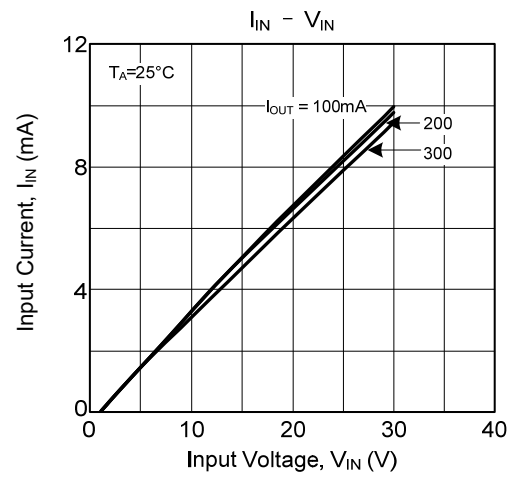
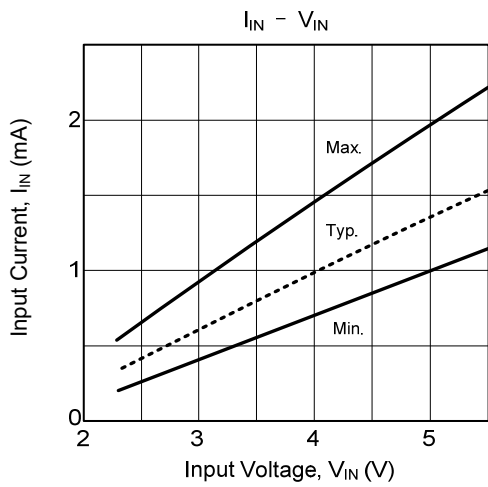

UTC assumes no responsibility for equipment failures that result from using products at values that exceed, even momentarily, rated values (such as maximum ratings, operating condition ranges, or other parameters) listed in products specifications of any and all UTC products described or contained herein. UTC products are not designed for use in life support appliances, devices or systems where malfunction of these products can be reasonably expected to result in personal injury. Reproduction in whole or in part is prohibited without the prior written consent of the copyright owner. UTC reserves the right to make changes to information published in this document, including without limitation specifications and product descriptions, at any time and without notice. This document supersedes and replaces all information supplied prior to the publication hereof.