



DTA124E

PNP EPITAXIAL SILICON TRANSISTOR

PNP DIGITAL TRANSISTOR (BUILT-IN RESISTORS)

■ FEATURES

- *Built-in bias resistors enable the configuration of an inverter circuit without connecting external input resistors (see the equivalent circuit).
- *The bias resistors consist of thin-film resistors with complete isolation to allow positive biasing of the input. They also have the advantage of almost completely eliminating parasitic effects.
- *Only the on / off conditions need to be set for operation, making device design easy.

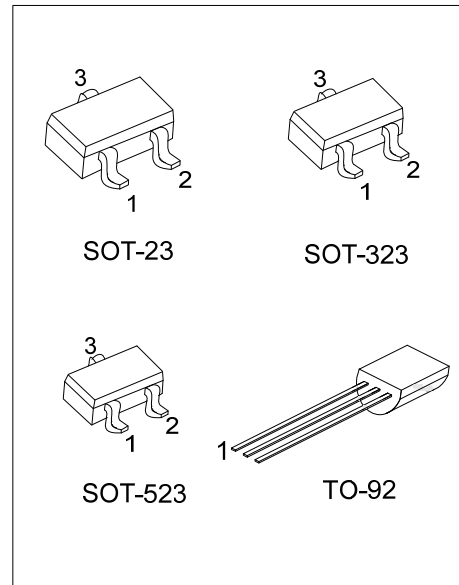

■ EQUIVALENT CIRCUIT

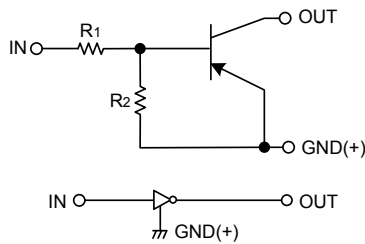

■ ORDERING INFORMATION

Ordering Number		Package	Pin Assignment			Packing
Lead Free	Halogen Free		1	2	3	
DTA124EL-AE3-R	DTA124EG-AE3-R	SOT-23	I	G	O	Tape Reel
DTA124EL-AL3-R	DTA124EG-AL3-R	SOT-323	I	G	O	Tape Reel
DTA124EL-AN3-R	DTA124EG-AN3-R	SOT-523	I	G	O	Tape Reel
DTA124EL-T92-B	DTA124EG-T92-B	TO-92	G	O	I	Tape Box
DTA124EL-T92-K	DTA124EG-T92-K	TO-92	G	O	I	Bulk

Note: Pin Assignment: I: IN G: GND O: OUT

<p>DTA124EG-AE3-R</p> <p>(1)Packing Type (2)Package Type (3)Green Package</p>	<p>(1) B: Tape Box, K: Bulk, R: Tape Reel (2) AE3: SOT-23, AL3: SOT-323, AN3: SOT-523 T92: TO-92 (3) G: Halogen Free and Lead Free, L: Lead Free</p>
---	--

DTA124E

PNP EPITAXIAL SILICON TRANSISTOR

MARKING

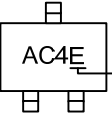
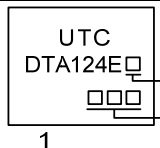
SOT-23 / SOT-323 / SOT-523	TO-92
 <p>AC4E</p> <p>E: Lead Free E: Halogen Free</p>	 <p>UTC DTA124E</p> <p>L: Lead Free G: Halogen Free Date Code</p> <p>1</p>

■ ABSOLUTE MAXIMUM RATINGS ($T_A = 25^\circ\text{C}$, unless otherwise specified)

PARAMETER		SYMBOL	RATINGS	UNIT
Supply Voltage		V_{CC}	-50	V
Input Voltage		V_{IN}	-40 ~ +10	V
Output Current		I_C	-100	mA
		I_O	-30	
Power Dissipation	SOT-23/SOT-323	P_D	200	mW
	SOT-523		150	
	TO-92		625	
Junction Temperature		T_J	+150	$^\circ\text{C}$
Storage Temperature		T_{STG}	-40 ~ +150	$^\circ\text{C}$

Note: Absolute maximum ratings are those values beyond which the device could be permanently damaged. Absolute maximum ratings are stress ratings only and functional device operation is not implied.

■ ELECTRICAL CHARACTERISTICS ($T_A = 25^\circ\text{C}$, unless otherwise specified)

PARAMETER	SYMBOL	TEST CONDITIONS	MIN	TYP	MAX	UNIT
Input Voltage	$V_{I(OFF)}$	$V_{CC} = -5V, I_{OUT} = -100\mu\text{A}$			-0.5	V
	$V_{I(ON)}$	$V_{OUT} = -0.2V, I_{OUT} = -5\text{mA}$	-3			
Output Voltage	$V_{O(ON)}$	$I_{OUT}/I_{IN} = -10\text{mA} / -0.5\text{mA}$		-0.1	-0.3	V
Input Current	I_I	$V_{IN} = -5V$			-0.36	mA
Output Current	$I_{O(OFF)}$	$V_{CC} = -50V, V_{IN} = 0V$			-0.5	μA
DC Current Gain	G_I	$V_{OUT} = -5V, I_{OUT} = -5\text{mA}$	56			
Input Resistance	R1		15.4	22	28.6	k Ω
Resistance Ratio	R2/R1		0.8	1	1.2	
Transition Frequency	f_T	$V_{CE} = -10V, I_E = 5\text{mA}, f = 100\text{MHz}$ (Note)		250		MHz

Note: Transition frequency of the device

TYPICAL CHARACTERISTICS

Fig.1 Input voltage vs.output current
(ON characteristics)

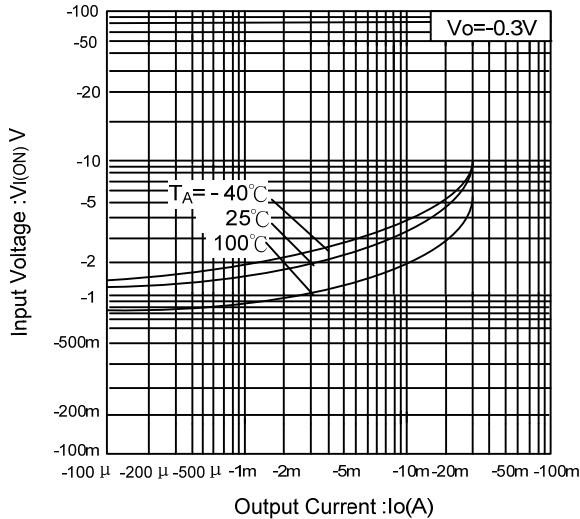

Fig.2 Output current vs Input voltage.
(OFF characteristics)

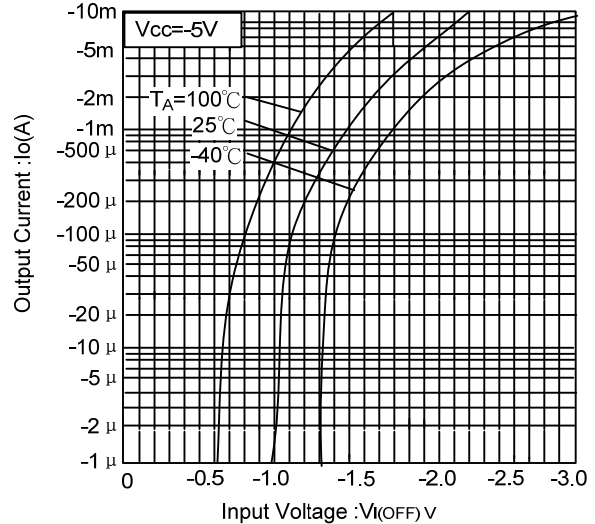

Fig.3 DC current gain vs.output current

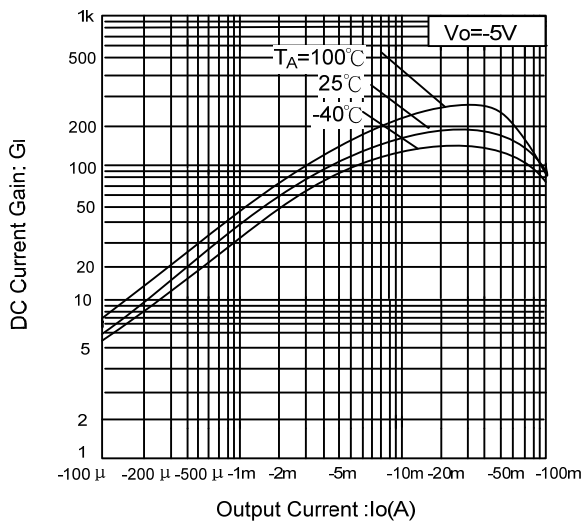
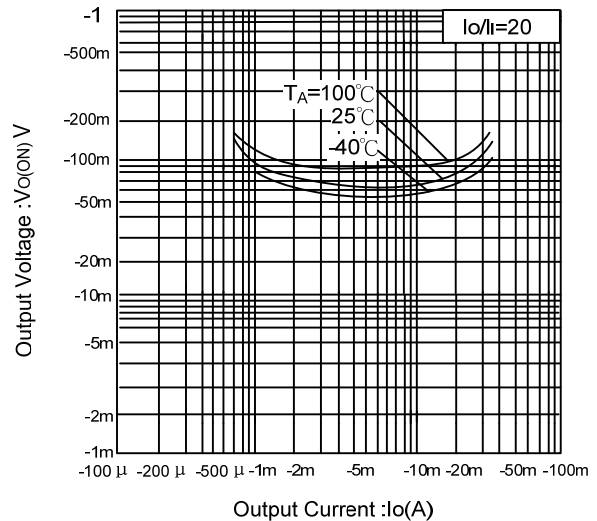

Fig.4 Output voltage vs.output current



UTC assumes no responsibility for equipment failures that result from using products at values that exceed, even momentarily, rated values (such as maximum ratings, operating condition ranges, or other parameters) listed in products specifications of any and all UTC products described or contained herein. UTC products are not designed for use in life support appliances, devices or systems where malfunction of these products can be reasonably expected to result in personal injury. Reproduction in whole or in part is prohibited without the prior written consent of the copyright owner. UTC reserves the right to make changes to information published in this document, including without limitation specifications and product descriptions, at any time and without notice. This document supersedes and replaces all information supplied prior to the publication hereof.