



MGBR10V45

DIODE

MOS GATED BARRIER RECTIFIER

DESCRIPTION

The UTC **MGBR10V45** is a surface mount mos gated barrier rectifier, it uses UTC's advanced technology to provide customers with low forward voltage drop and high switching speed, etc.

FEATURES

- * Very low forward voltage drop
- * High switching speed

SYMBOL

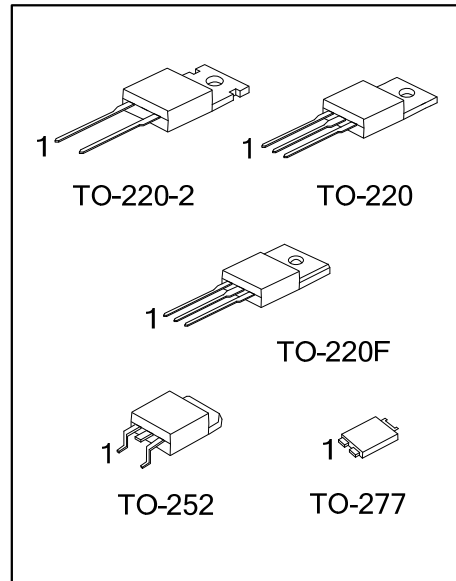
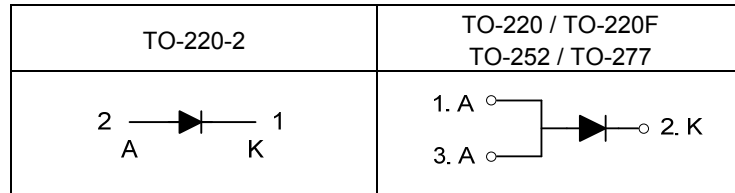

ORDERING INFORMATION

Ordering Number		Package	Pin Assignment			Packing
Lead Free	Halogen Free		1	2	3	
MGBR10V45L-TA2-T	MGBR10V45G-TA2-T	TO-220-2	K	A	-	Tube
MGBR10V45L-TA3-T	MGBR10V45G-TA3-T	TO-220	A	K	A	Tape Reel
MGBR10V45L-TF3-T	MGBR10V45G-TF3-T	TO-220F	A	K	A	Tape Reel
MGBR10V45L-TN3-R	MGBR10V45G-TN3-R	TO-252	A	K	A	Tape Reel
MGBR10V45L-T27-R	MGBR10V45G-T27-R	TO-277	A	K	A	Tape Reel

Note: Pin Assignment: A: Anode K: Common Cathode

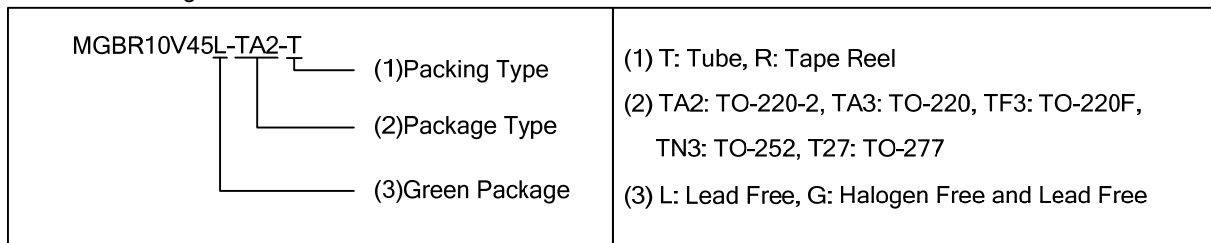

MARKING

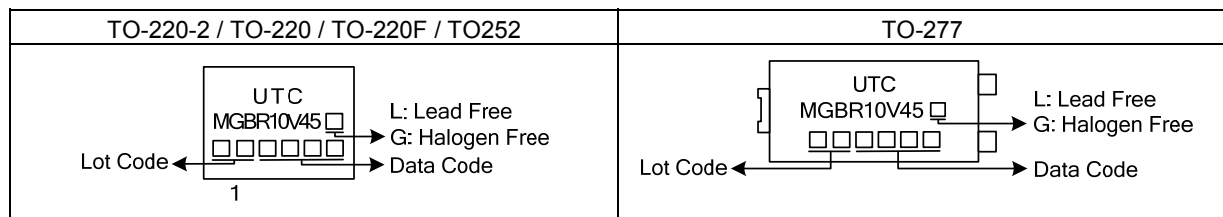

■ ABSOLUTE MAXIMUM RATINGS (T_A=25°C, unless otherwise specified)

Single phase, half wave, 60Hz, resistive or inductive load.

For capacitance load, derate current by 20%.

PARAMETER	SYMBOL	RATINGS	UNIT
DC Blocking Voltage	V _{RM}	45	V
Working Peak Reverse Voltage	V _{RWM}	45	V
Peak Repetitive Reverse Voltage	V _{RRM}	45	V
RMS Reverse Voltage	V _{R(RMS)}	32	V
Average Rectified Output Current	I _O	10	A
Non-Repetitive Peak Forward Surge Current 8.3ms Single Half Sine-Wave Superimposed on Rated Load	I _{FSM}	150	A
Operating Junction Temperature	T _J	-65~+150	°C
Storage Temperature	T _{STG}	-65~+150	°C

Note: Absolute maximum ratings are those values beyond which the device could be permanently damaged. Absolute maximum ratings are stress ratings only and functional device operation is not implied.

■ THERMAL CHARACTERISTICS

PARAMETER	SYMBOL	RATINGS	UNIT
Junction to Ambient	θ _{JA}	60	°C/W
		110	
		73 (Note 3)	
Junction to Case	θ _{JC}	2	°C/W
		3.31	
		2.5	
		13 (Note 3)	

■ ELECTRICAL CHARACTERISTICS (T_A=25°C, unless otherwise specified.)

PARAMETER	SYMBOL	TEST CONDITIONS	MIN	TYP	MAX	UNIT
Reverse Breakdown Voltage (Note 1)	V _{(BR)R}	I _R =0.5mA	45			V
Instantaneous Forward Voltage	V _{FM}	I _F =10A, T _J =25°C			0.53	V
		I _F =10A, T _J =125°C			0.48	V
Leakage Current (Note 1)	I _{RM}	V _R =45V, T _J =25°C		50	500	µA
		V _R =45V, T _J =125°C		12	40	mA
Total Capacitance	C _T	V _R =5V, f=1MHz, T _J =25°C		400		pF

Notes: 1. Short duration pulse test used to minimize self-heating effect.

2. Thermal resistance junction to case mounted on heatsink.

3. Mounted on an FR4 PCB, single-sided copper, with 100cm² copper pad area.

■ TYPICAL CHARACTERISTICS

Forward Derating Curve

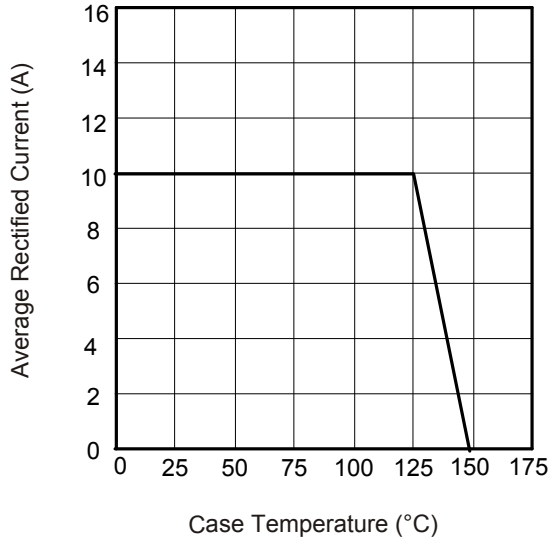

Typical Forward Characteristics

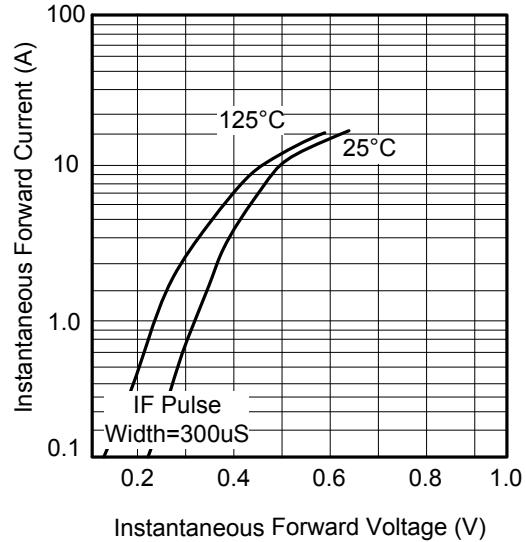

Typical Reverse Characteristics

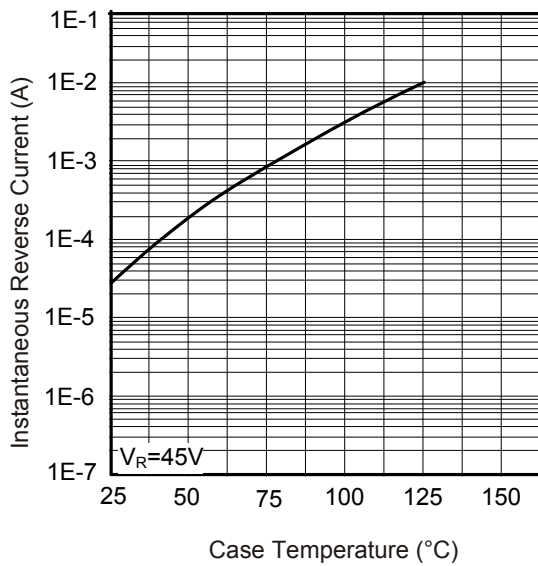

UTC assumes no responsibility for equipment failures that result from using products at values that exceed, even momentarily, rated values (such as maximum ratings, operating condition ranges, or other parameters) listed in products specifications of any and all UTC products described or contained herein. UTC products are not designed for use in life support appliances, devices or systems where malfunction of these products can be reasonably expected to result in personal injury. Reproduction in whole or in part is prohibited without the prior written consent of the copyright owner. The information presented in this document does not form part of any quotation or contract, is believed to be accurate and reliable and may be changed without notice.