



# 4N60Z

**Power MOSFET**

## 4A, 600V N-CHANNEL POWER MOSFET

### DESCRIPTION

The UTC **4N60Z** is a high voltage power MOSFET and is designed to have better characteristics, such as fast switching time, low gate charge, low on-state resistance and have a high rugged avalanche characteristics. This power MOSFET is usually used at high speed switching applications in power supplies, PWM motor controls, high efficient DC to DC converters and bridge circuits.

### FEATURES

- \*  $R_{DS(ON)} < 2.5\Omega @ V_{GS} = 10V$
- \* Ultra Low Gate Charge ( typical 15 nC )
- \* Low Reverse Transfer Capacitance (  $C_{RSS} = \text{typical } 8.0 \text{ pF}$  )
- \* Fast Switching Capability
- \* Avalanche Energy Specified
- \* Improved dv/dt Capability, high Ruggedness

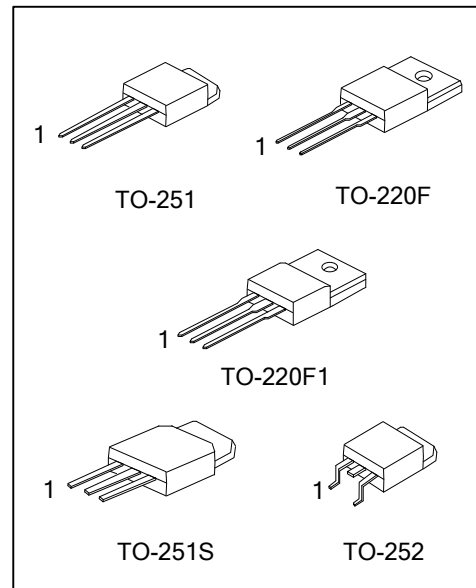

### SYMBOL

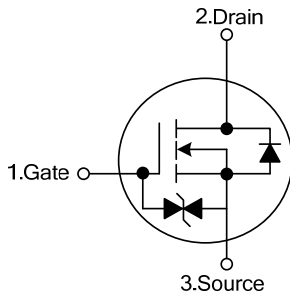

### ORDERING INFORMATION

Ordering Number		Package	Pin Assignment			Packing
Lead Free	Halogen Free		1	2	3	
4N60ZL-TF3-T	4N60ZG-TF3-T	TO-220F	G	D	S	Tube
4N60ZL-TF1-T	4N60ZG-TF1-T	TO-220F1	G	D	S	Tube
4N60ZL-TM3-T	4N60ZG-TM3-T	TO-251	G	D	S	Tube
4N60ZL-TMS-T	4N60ZG-TMS-T	TO-251S	G	D	S	Tube
4N60ZL-TN3-R	4N60ZG-TN3-R	TO-252	G	D	S	Tape Reel

Note: Pin Assignment: G: Gate D: Drain S: Source

<p>4N60ZG-TF3-T</p>	<p>(1) T: Tube, R: Tape Reel</p> <p>(2) TF3: TO-220F, TF1: TO-220F1, TM3: TO-251, TMS: TO-251S, TN3: TO-252</p> <p>(3) G: Halogen Free and Lead Free, L: Lead Free</p>
---------------------	--

MARKING

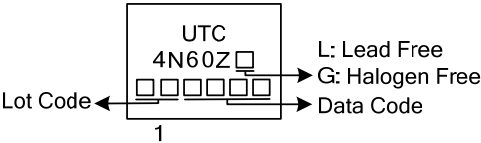

■ ABSOLUTE MAXIMUM RATINGS ( $T_C=25^\circ\text{C}$ , unless otherwise specified)

PARAMETER		SYMBOL	RATINGS	UNIT
Drain-Source Voltage		$V_{DSS}$	600	V
Gate-Source Voltage		$V_{GSS}$	$\pm 20$	V
Avalanche Current (Note 2)		$I_{AR}$	4.4	A
Drain Current	Continuous	$I_D$	4.0	A
	Pulsed (Note 2)	$I_{DM}$	16	A
Avalanche Energy	Single Pulsed (Note 3)	$E_{AS}$	260	mJ
	Repetitive (Note 2)	$E_{AR}$	10.6	mJ
Peak Diode Recovery dv/dt (Note 4)		dv/dt	4.5	V/ns
Power Dissipation	TO-220F/TO-220F1	$P_D$	36	W
	TO-251/TO-251S		50	
	TO-252			
Junction Temperature		$T_J$	+150	$^\circ\text{C}$
Operating Temperature		$T_{OPR}$	-55 ~ +150	$^\circ\text{C}$
Storage Temperature		$T_{STG}$	-55 ~ +150	$^\circ\text{C}$

Notes: 1. Absolute maximum ratings are those values beyond which the device could be permanently damaged.

Absolute maximum ratings are stress ratings only and functional device operation is not implied.

2. Repetitive Rating : Pulse width limited by maximum junction temperature

3.  $L = 30\text{mH}$ ,  $I_{AS} = 4\text{A}$ ,  $V_{DD} = 50\text{V}$ ,  $R_G = 25\ \Omega$ , Starting  $T_J = 25^\circ\text{C}$

4.  $I_{SD} \leq 4.4\text{A}$ ,  $di/dt \leq 200\text{A}/\mu\text{s}$ ,  $V_{DD} \leq BV_{DSS}$ , Starting  $T_J = 25^\circ\text{C}$

■ THERMAL DATA

PARAMETER	PACKAGE	SYMBOL	RATINGS	UNIT
Junction to Ambient	TO-220F/TO-220F1	$\theta_{JA}$	62.5	$^\circ\text{C}/\text{W}$
	TO-251/TO-251S		110	
	TO-252		3.47	
	TO-220F/TO-220F1		2.5	
	TO-251/TO-251S			
	TO-252			

■ ELECTRICAL CHARACTERISTICS ( $T_C=25^\circ\text{C}$ , unless otherwise specified)

PARAMETER	SYMBOL	TEST CONDITIONS	MIN	TYP	MAX	UNIT
<b>OFF CHARACTERISTICS</b>						
Drain-Source Breakdown Voltage	$BV_{DSS}$	$V_{GS} = 0V, I_D = 250\mu A$	600			V
Drain-Source Leakage Current	$I_{DSS}$	$V_{DS} = 600V, V_{GS} = 0V$			10	$\mu A$
Gate-Source Leakage Current	Forward	$I_{GSS}$			5	$\mu A$
	Reverse				-5	$\mu A$
Breakdown Voltage Temperature Coefficient	$\Delta BV_{DSS}/\Delta T_J$	$I_D=250\mu A$ , Referenced to $25^\circ\text{C}$		0.6		$V/^\circ\text{C}$
<b>ON CHARACTERISTICS</b>						
Gate Threshold Voltage	$V_{GS(TH)}$	$V_{DS} = V_{GS}, I_D = 250\mu A$	2.0		4.0	V
Static Drain-Source On-State Resistance	$R_{DS(ON)}$	$V_{GS} = 10V, I_D = 2.2A$		2.2	2.5	$\Omega$
<b>DYNAMIC CHARACTERISTICS</b>						
Input Capacitance	$C_{ISS}$	$V_{DS} = 25V, V_{GS} = 0V,$ $f = 1\text{MHz}$		520	670	pF
Output Capacitance	$C_{OSS}$			70	90	pF
Reverse Transfer Capacitance	$C_{RSS}$			8	11	pF
<b>SWITCHING CHARACTERISTICS</b>						
Turn-On Delay Time	$t_{D(ON)}$	$V_{DD} = 300V, I_D = 4.0A,$ $R_G = 25\Omega$ (Note 1, 2)		13	35	ns
Turn-On Rise Time	$t_R$			45	100	ns
Turn-Off Delay Time	$t_{D(OFF)}$			25	60	ns
Turn-Off Fall Time	$t_F$			35	80	ns
Total Gate Charge	$Q_G$	$V_{DS} = 480V, I_D = 4.0A,$ $V_{GS} = 10V$ (Note 1, 2)		15	20	nC
Gate-Source Charge	$Q_{GS}$			3.4		nC
Gate-Drain Charge	$Q_{GD}$			7.1		nC
<b>SOURCE- DRAIN DIODE RATINGS AND CHARACTERISTICS</b>						
Drain-Source Diode Forward Voltage	$V_{SD}$	$V_{GS} = 0V, I_S = 4.4A$			1.4	V
Maximum Continuous Drain-Source Diode Forward Current	$I_S$				4.4	A
Maximum Pulsed Drain-Source Diode Forward Current	$I_{SM}$				17.6	A
Reverse Recovery Time	$t_{rr}$	$V_{GS} = 0V, I_S = 4.4A,$ $di_F/dt = 100A/\mu s$ (Note 1)		250		ns
Reverse Recovery Charge	$Q_{RR}$			1.5		$\mu C$

Notes: 1. Pulse Test: Pulse width  $\leq 300\mu s$ , Duty cycle  $\leq 2\%$   
2. Essentially independent of operating temperature

## TEST CIRCUITS AND WAVEFORMS



**Peak Diode Recovery  $dv/dt$  Test Circuit**

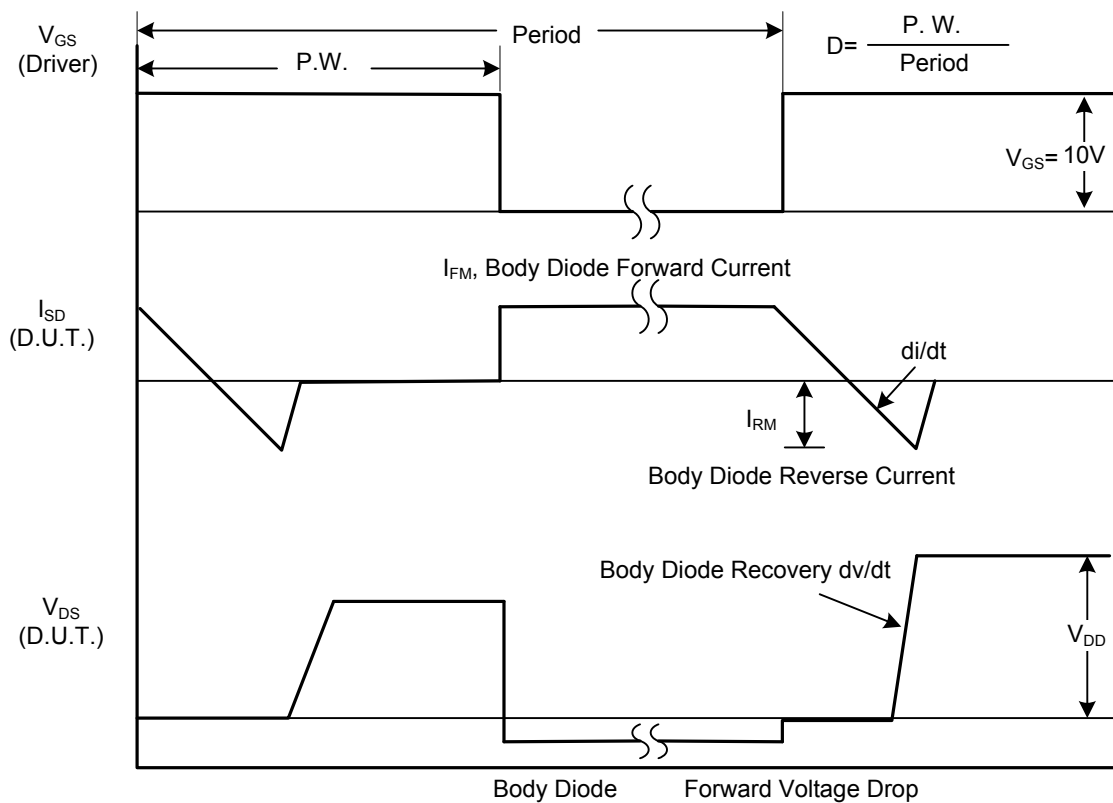

**Peak Diode Recovery  $dv/dt$  Waveforms**

## ■ TEST CIRCUITS AND WAVEFORMS (Cont.)



**Switching Test Circuit**

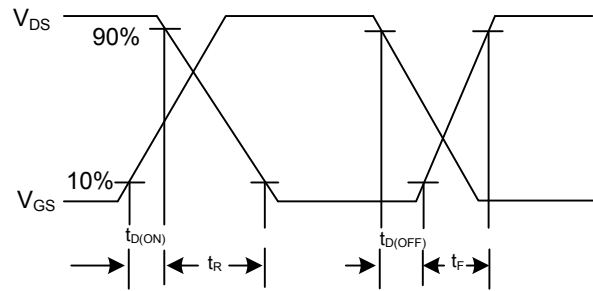

**Switching Waveforms**

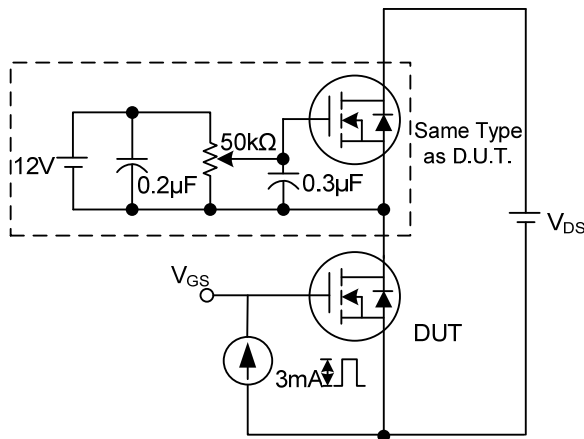

**Gate Charge Test Circuit**

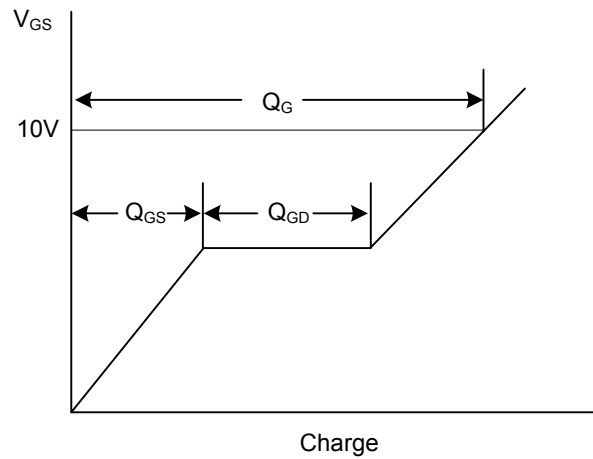

**Gate Charge Waveform**



**Unclamped Inductive Switching Test Circuit**



**Unclamped Inductive Switching Waveforms**

## TYPICAL CHARACTERISTICS

Breakdown Voltage Variation vs. Temperature

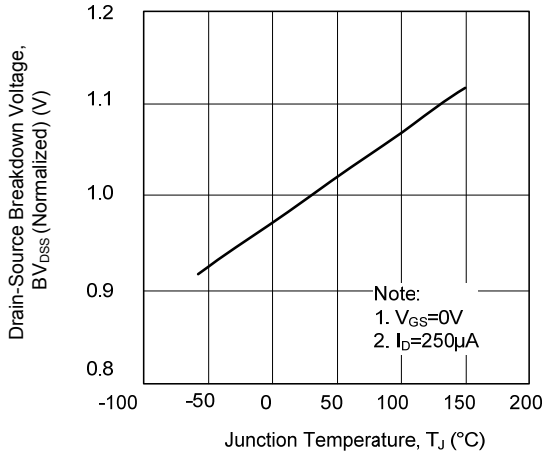

On-Resistance Junction Temperature

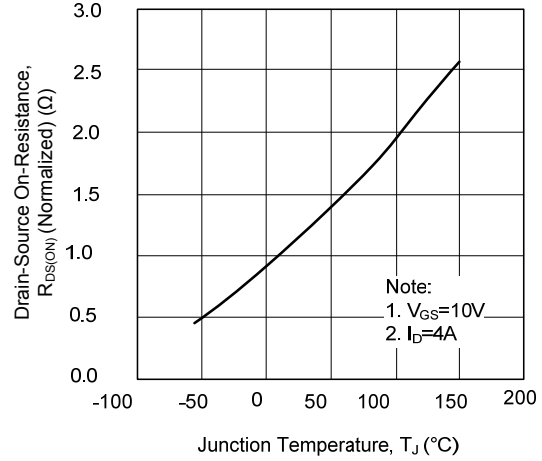

Safe Operating Area - 600V

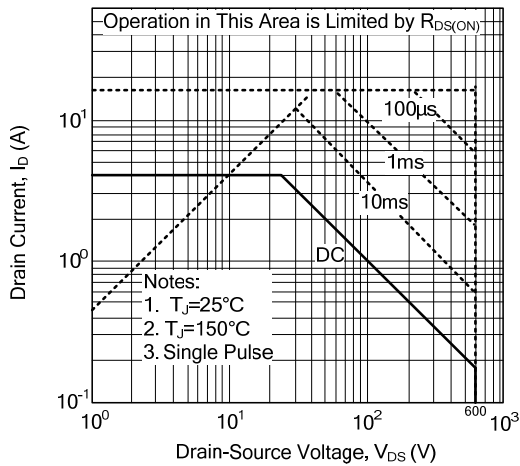

Maximum Drain Current vs. Case Temperature

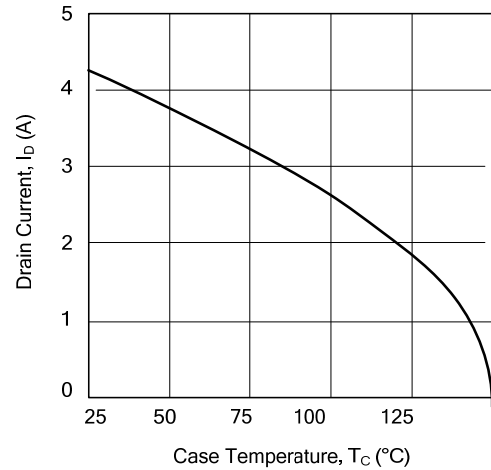

On-State Characteristics

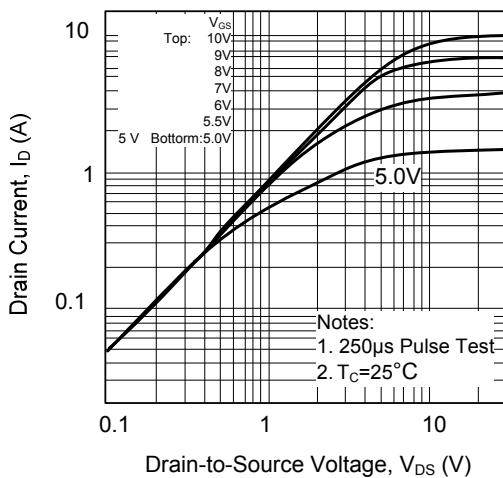

Transfer Characteristics

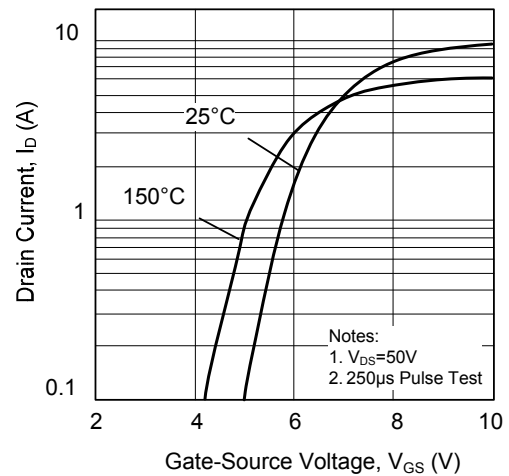

## ■ TYPICAL CHARACTERISTICS(Cont.)

On-Resistance Variation vs. Drain Current and Gate Voltage

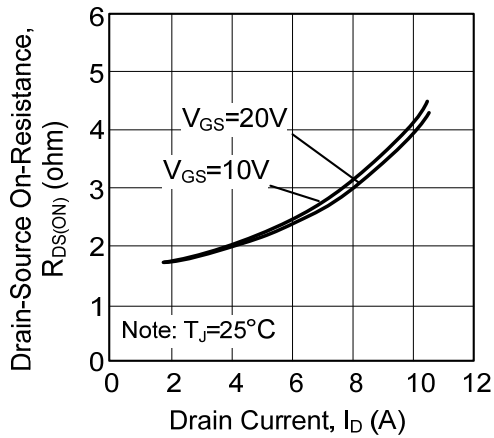

On State Current vs. Allowable Case Temperature

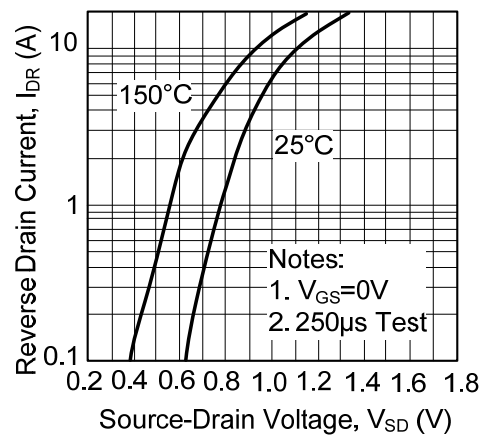

Capacitance Characteristics (Non-Repetitive)

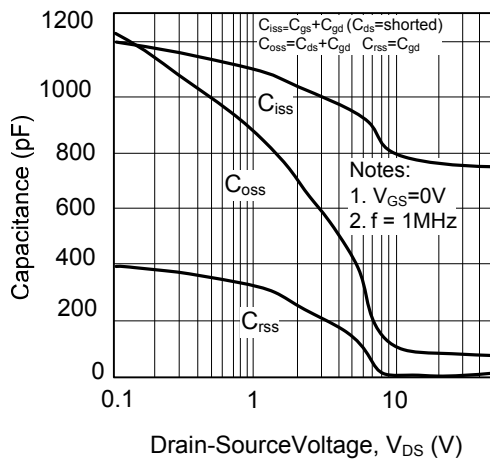

Gate Charge Characteristics

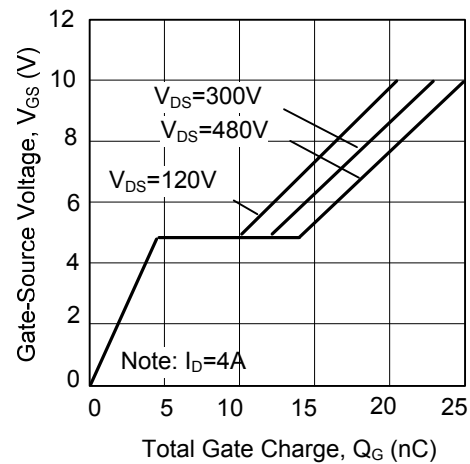

Transient Thermal Response Curve

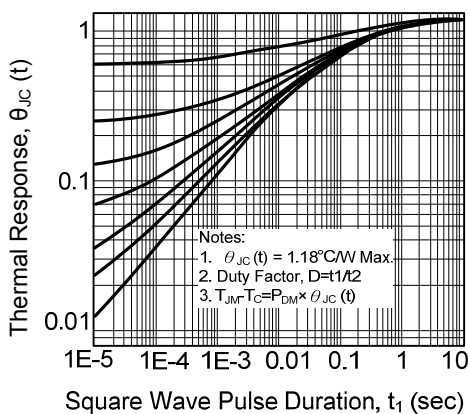

Power Dissipation

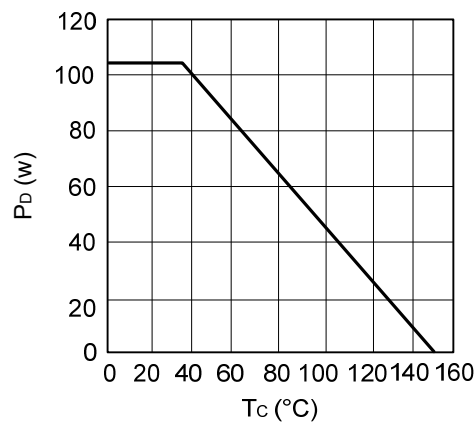



UTC assumes no responsibility for equipment failures that result from using products at values that exceed, even momentarily, rated values (such as maximum ratings, operating condition ranges, or other parameters) listed in products specifications of any and all UTC products described or contained herein. UTC products are not designed for use in life support appliances, devices or systems where malfunction of these products can be reasonably expected to result in personal injury. Reproduction in whole or in part is prohibited without the prior written consent of the copyright owner. The information presented in this document does not form part of any quotation or contract, is believed to be accurate and reliable and may be changed without notice.