



UT5003

Power MOSFET

DUAL ENHANCEMENT MODE (N-CHANNEL/P-CHANNEL)

DESCRIPTION

The **UT5003** can provide excellent $R_{DS(ON)}$ and low gate charge by using UTC's advanced trench technology. This device is suitable for use as a load switch or in PWM applications.

FEATURES

- * N-Channel: 30V, 7A
 $R_{DS(ON)} < 27.5m\Omega @ V_{GS}=10V, I_D=7A$
 $R_{DS(ON)} < 40m\Omega @ V_{GS}=4.5V, I_D=6A$
- * P-Channel: -30V, -5A
 $R_{DS(ON)} < 45m\Omega @ V_{GS}=-10V, I_D=-5A$
 $R_{DS(ON)} < 80m\Omega @ V_{GS}=-4.5V, I_D=-4A$
- * Super high dense cell design
- * Reliable and rugged

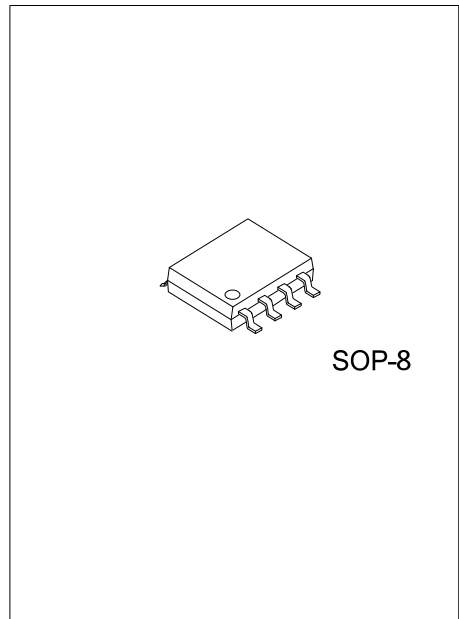

SYMBOL

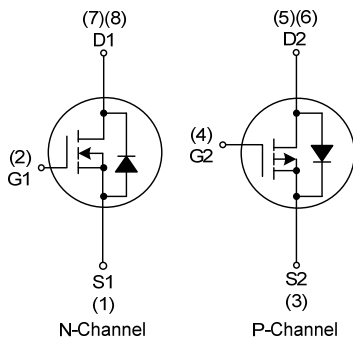

ORDERING INFORMATION

Ordering Number	Package	Pin Assignment								Packing
		1	2	3	4	5	6	7	8	
UT5003G-S08-R	SOP-8	S1	G1	S2	G2	D2	D2	D1	D1	Tape Reel

Note: Pin Assignment: G: Gate D: Drain S: Source

<p>UT5003G-S08-R</p> <ul style="list-style-type: none"> (1) Packing Type (2) Package Type (3) Green Package 	<ul style="list-style-type: none"> (1) R: Tape Reel (2) S08: SOP-8 (3) G: Halogen Free and Lead Free
--	---

MARKING

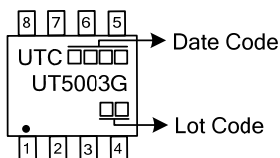

■ ABSOLUTE MAXIMUM RATINGS ($T_A=25^{\circ}\text{C}$ unless otherwise specified)

N-Channel:

PARAMETER	SYMBOL	RATINGS	UNIT
Drain-Source Voltage	V_{DSS}	30	V
Gate-Source Voltage	V_{GSS}	± 20	V
Continuous Drain Current (Note3)	I_D	7	A
Pulsed Drain Current (Note3)	I_{DM}	20	A
Power Dissipation	P_D	2	W
Junction Temperature	T_J	+150	$^{\circ}\text{C}$
Storage Temperature	T_{STG}	-55 ~ +150	$^{\circ}\text{C}$

P-Channel:

PARAMETER	SYMBOL	RATINGS	UNIT
Drain-Source Voltage	V_{DSS}	-30	V
Gate-Source Voltage	V_{GSS}	± 20	V
Continuous Drain Current (Note3)	I_D	-5	A
Pulsed Drain Current (Note3)	I_{DM}	-20	A
Power Dissipation	P_D	2	W
Junction Temperature	T_J	+150	$^{\circ}\text{C}$
Storage Temperature	T_{STG}	-55 ~ +150	$^{\circ}\text{C}$

Note: Absolute maximum ratings are those values beyond which the device could be permanently damaged. Absolute maximum ratings are stress ratings only and functional device operation is not implied.

■ THERMAL DATA

PARAMETER	SYMBOL	RATINGS	UNIT
Junction to Ambient (Note3)	θ_{JA}	62.5	$^{\circ}\text{C}/\text{W}$

■ ELECTRICAL CHARACTERISTICS ($T_A=25^{\circ}\text{C}$, unless otherwise specified)

N-CHANNEL

PARAMETER	SYMBOL	TEST CONDITIONS	MIN	TYP	MAX	UNIT
OFF CHARACTERISTICS						
Drain-Source Breakdown Voltage	BV_{DSS}	$V_{GS}=0\text{V}, I_D=250\mu\text{A}$	30			V
Drain-Source Leakage Current	I_{DSS}	$V_{DS}=24\text{V}, V_{GS}=0\text{V}$			1	μA
Gate-Source Leakage Current	I_{GSS}	$V_{DS}=0\text{V}, V_{GS}=\pm 20\text{V}$			± 100	nA
ON CHARACTERISTICS						
Gate Threshold Voltage	$V_{GS(TH)}$	$V_{DS}=V_{GS}, I_D=250\mu\text{A}$	1	1.5	2.5	V
Drain-Source On-State Resistance (Note2)	$R_{DS(ON)}$	$V_{GS}=10\text{V}, I_D=7\text{A}$		20.5	27.5	$\text{m}\Omega$
		$V_{GS}=4.5\text{V}, I_D=6\text{A}$		30	40	$\text{m}\Omega$
DYNAMIC CHARACTERISTICS						
Input Capacitance	C_{ISS}	$V_{GS}=0\text{V}, V_{DS}=15\text{V}, f=1\text{MHz}$		680		pF
Output Capacitance	C_{OSS}			105		pF
Reverse Transfer Capacitance	C_{RSS}			75		pF
SWITCHING CHARACTERISTICS						
Turn-ON Delay Time (Note2)	$t_{D(ON)}$	$V_{DS}=10\text{V}, V_{GS}=10\text{V}, I_D=1\text{A}, R_G=3\Omega$		4.6	7	ns
Turn-ON Rise Time	t_R			4	6	ns
Turn-OFF Delay Time	$t_{D(OFF)}$			20	30	ns
Turn-OFF Fall Time	t_F			5	8	ns
Total Gate Charge (Note2)	Q_G	$V_{DS}=0.5 \cdot BV_{DSS}, V_{GS}=10\text{V}, I_D=7\text{A}$		14		nC
Gate-Source Charge	Q_{GS}			1.9		nC
Gate-Drain Charge	Q_{GD}			3.3		nC
SOURCE- DRAIN DIODE RATINGS AND CHARACTERISTICS						
Drain-Source Diode Forward Voltage(Note2)	V_{SD}	$I_S=1\text{A}, V_{GS}=0\text{V}$			1	V
Diode Continuous Forward Current	I_S				1.3	A

■ ELECTRICAL CHARACTERISTICS (Cont.)

P-CHANNEL

PARAMETER	SYMBOL	TEST CONDITIONS	MIN	TYP	MAX	UNIT
OFF CHARACTERISTICS						
Drain-Source Breakdown Voltage	BV_{DSS}	$V_{GS}=0V, I_D=-250\mu A$	-30			V
Drain-Source Leakage Current	I_{DSS}	$V_{DS}=-24V, V_{GS}=0V$			-1	μA
Gate-Source Leakage Current	I_{GSS}	$V_{DS}=0V, V_{GS}=\pm 20V$			± 100	nA
ON CHARACTERISTICS						
Gate Threshold Voltage	$V_{GS(TH)}$	$V_{DS}=V_{GS}, I_D=-250\mu A$	-1	-1.5	-2.5	V
Drain-Source On-State Resistance (Note2)	$R_{DS(ON)}$	$V_{GS}=-10V, I_D=-5A$		37.5	45	m Ω
		$V_{GS}=-4.5V, I_D=-4A$		62	80	m Ω
DYNAMIC CHARACTERISTICS						
Input Capacitance	C_{ISS}	$V_{GS}=0V, V_{DS}=-15V, f=1MHz$		780		pF
Output Capacitance	C_{OSS}			145		pF
Reverse Transfer Capacitance	C_{RSS}			79		pF
SWITCHING CHARACTERISTICS						
Turn-ON Delay Time (Note2)	$t_{D(ON)}$	$V_{DS}=-10V, V_{GS}=-10V, I_D=1A, R_G=3\Omega$		7.7	11.5	ns
Turn-ON Rise Time	t_R			5.7	8.5	ns
Turn-OFF Delay Time	$t_{D(OFF)}$			20	30	ns
Turn-OFF Fall Time	t_F			9.5	14	ns
Total Gate Charge (Note2)	Q_G	$V_{DS}=0.5 \cdot BV_{DSS}, V_{GS}=-10V, I_D=-5A$		15.1		nC
Gate-Source Charge	Q_{GS}			2.1		nC
Gate-Drain Charge	Q_{GD}			4.0		nC
SOURCE- DRAIN DIODE RATINGS AND CHARACTERISTICS						
Drain-Source Diode Forward Voltage(Note2)	V_{SD}	$I_S=-1A, V_{GS}=0V$			-1	V
Diode Continuous Forward Current	I_S				-1.3	A

- Notes: 1. Pulse width limited by $T_{J(MAX)}$
 2. Pulse width $\leq 300\mu s$, duty cycle $\leq 2\%$.
 3. Surface Mounted on $1in^2$ pad area, $t \leq 10sec$.

TYPICAL CHARACTERISTICS

N-CHANNEL:

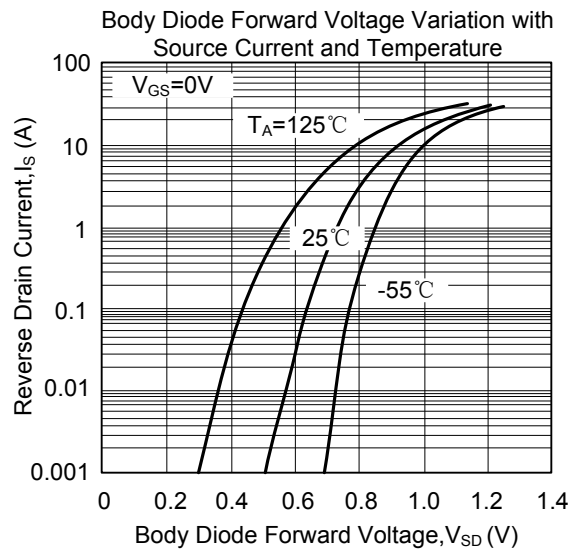
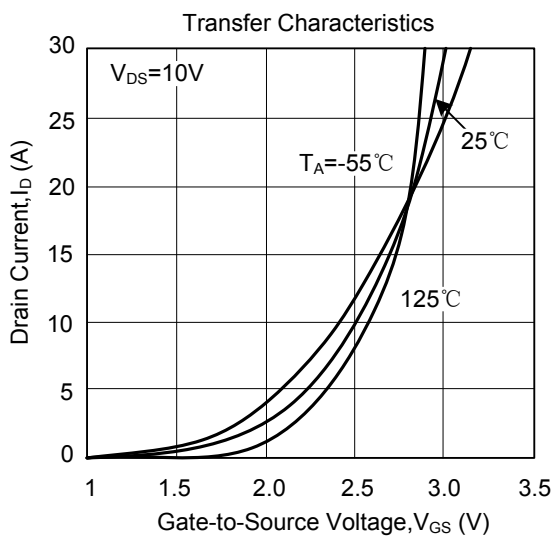
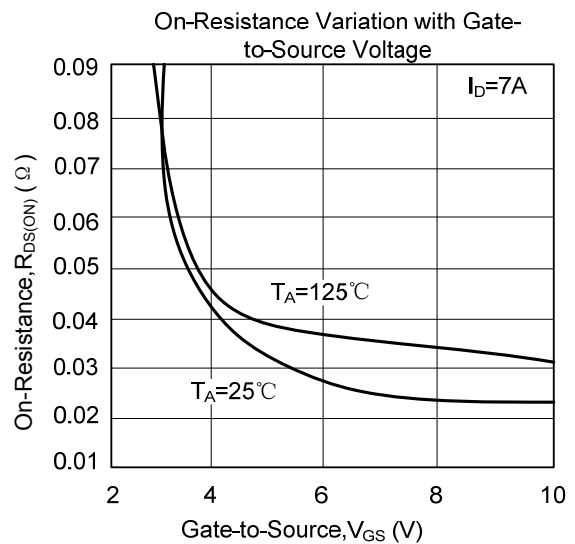
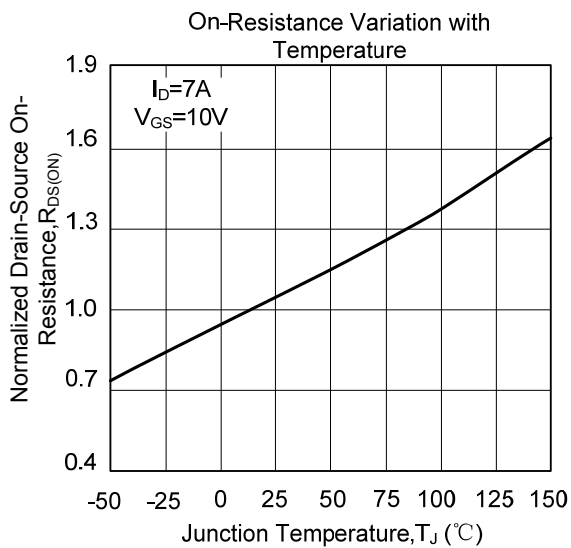
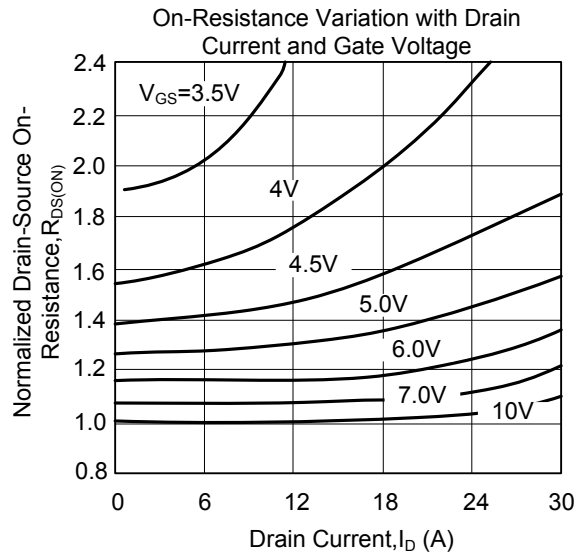
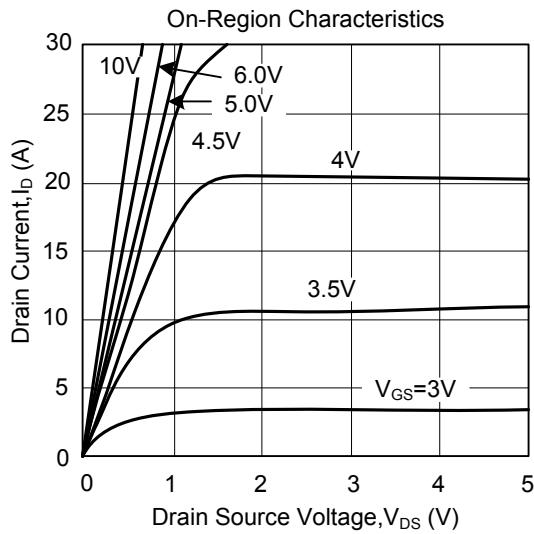

TYPICAL CHARACTERISTICS(Cont.)

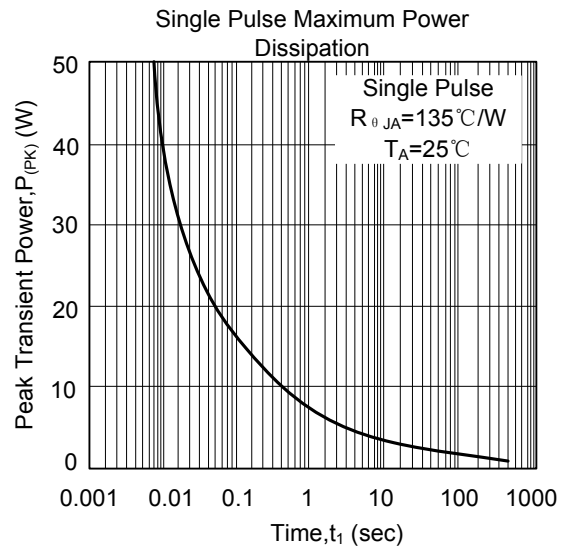
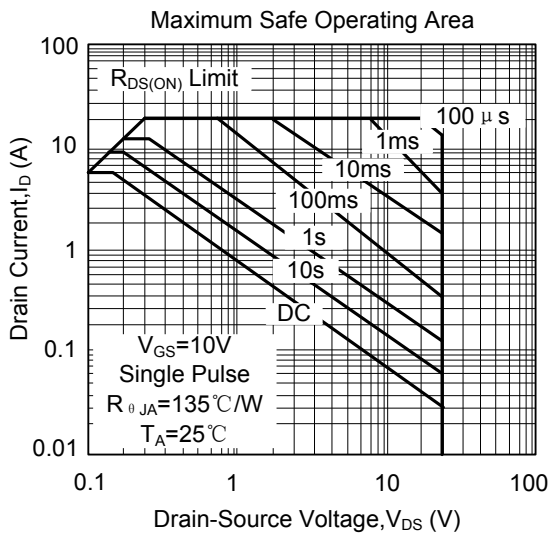
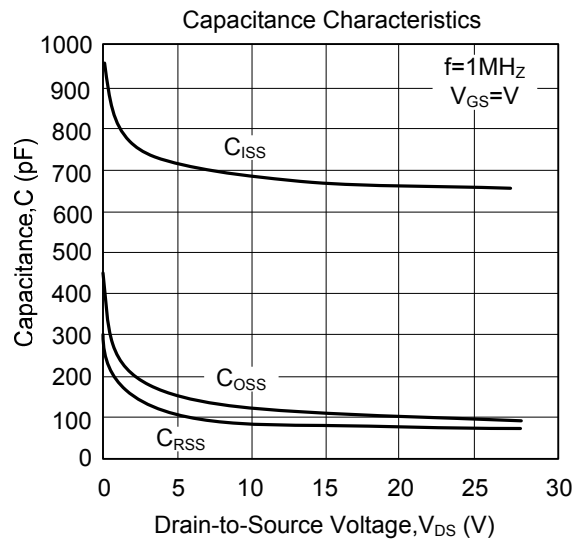
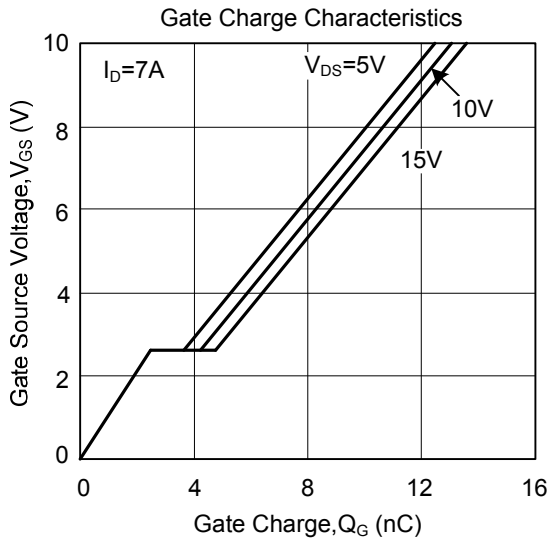

P-CHANNEL

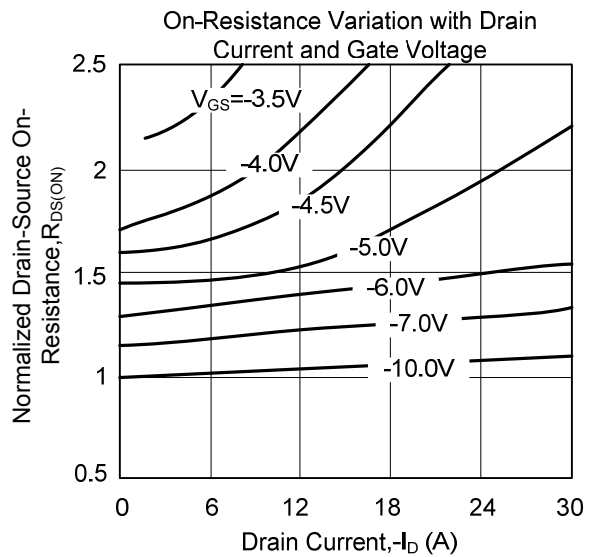
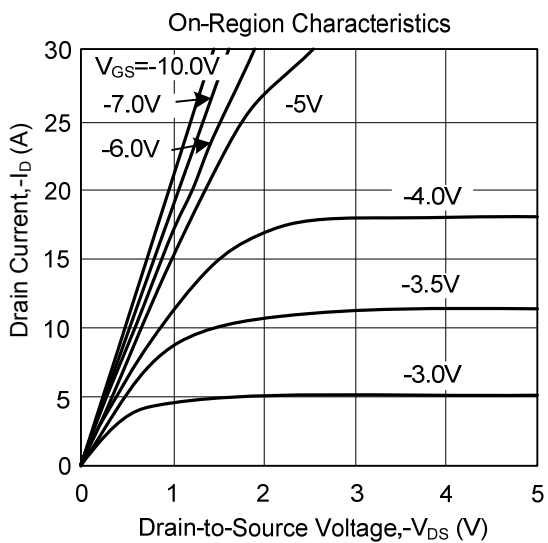

TYPICAL CHARACTERISTICS(Cont.)

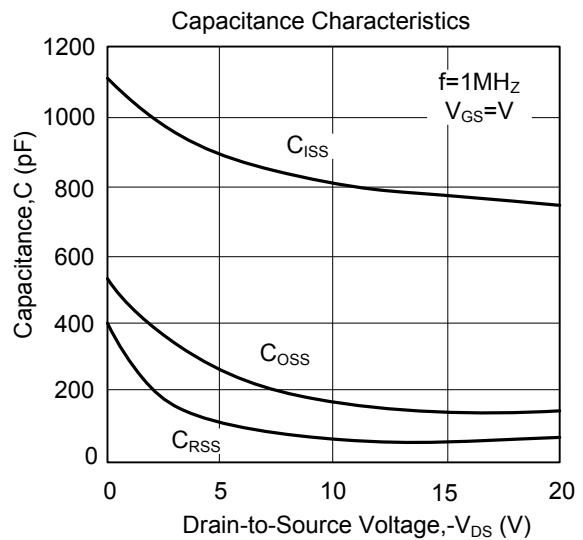
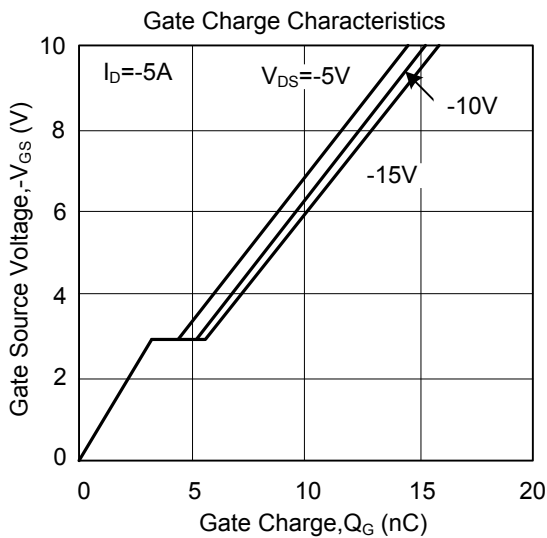
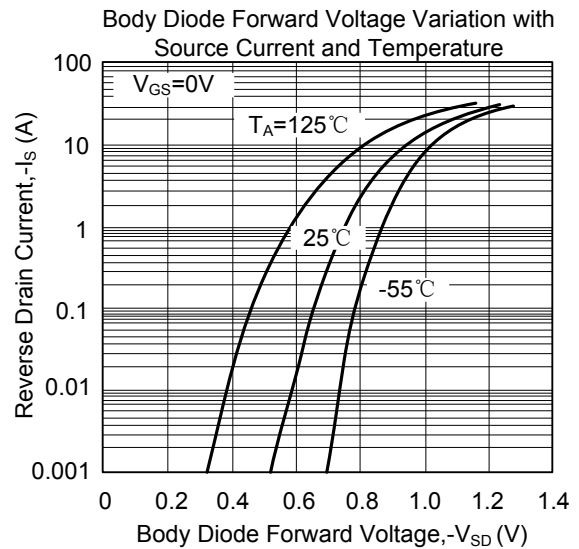
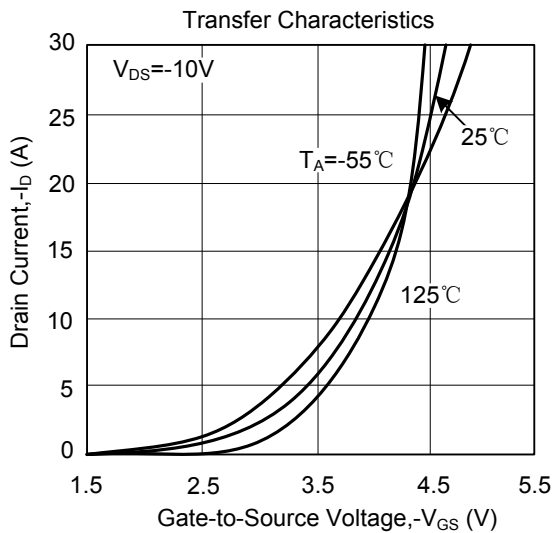
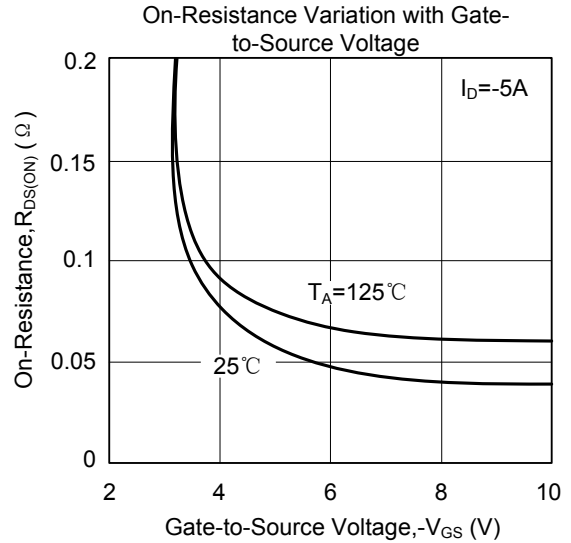
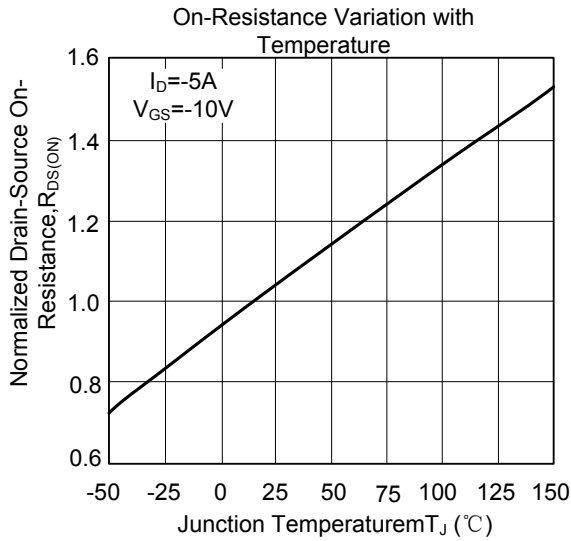

■ TYPICAL CHARACTERISTICS(Cont.)

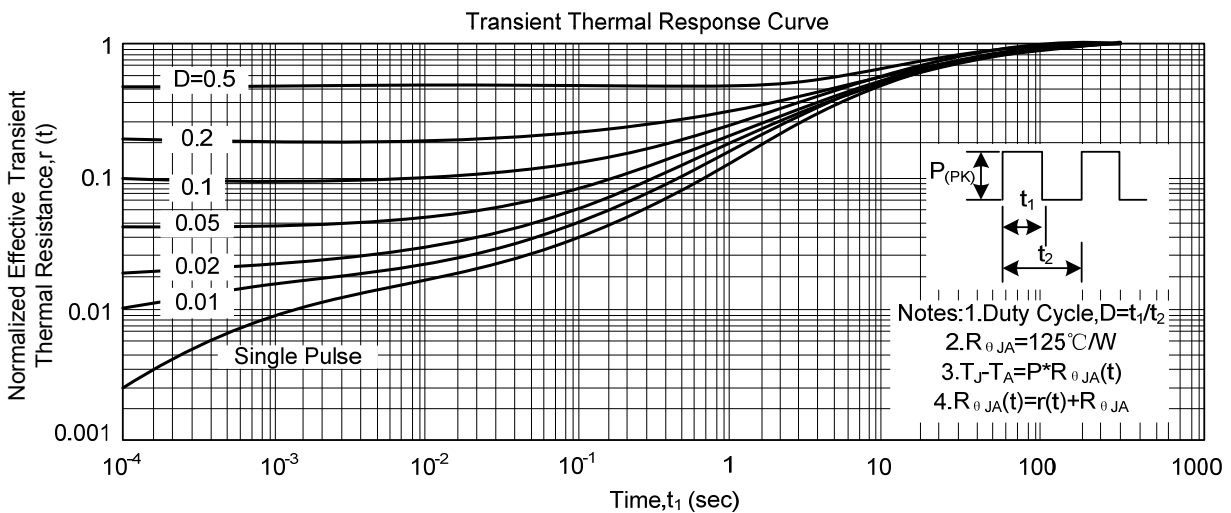
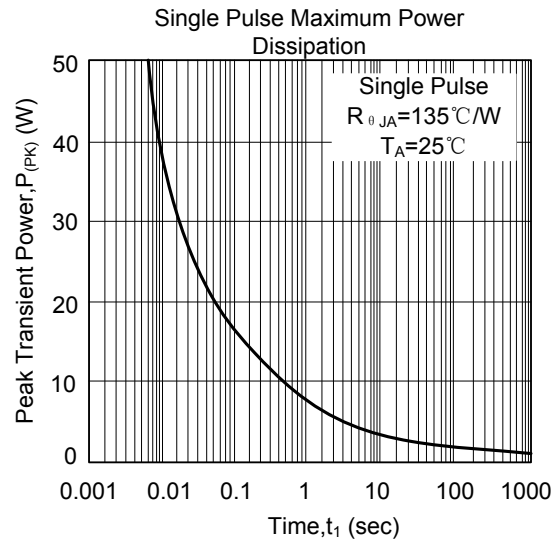
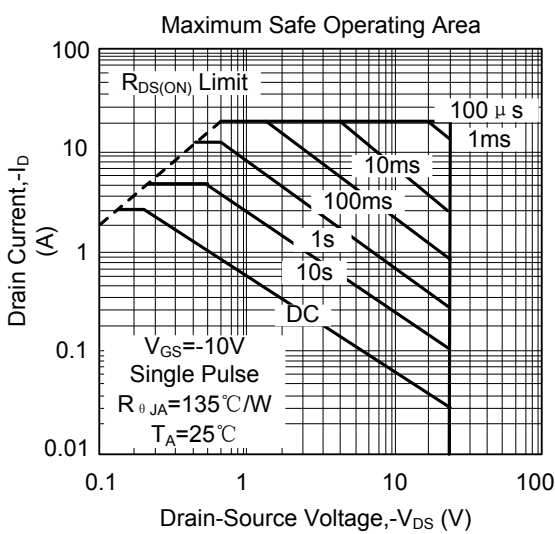

UTC assumes no responsibility for equipment failures that result from using products at values that exceed, even momentarily, rated values (such as maximum ratings, operating condition ranges, or other parameters) listed in products specifications of any and all UTC products described or contained herein. UTC products are not designed for use in life support appliances, devices or systems where malfunction of these products can be reasonably expected to result in personal injury. Reproduction in whole or in part is prohibited without the prior written consent of the copyright owner. The information presented in this document does not form part of any quotation or contract, is believed to be accurate and reliable and may be changed without notice.