



UTM2513

Power MOSFET

N-CHANNEL ENHANCEMENT MODE

■ FEATURES

- * $R_{DS(ON)} = 10.5m\Omega$ (typ.) @ $V_{GS} = 10 V$
- * $R_{DS(ON)} = 16m\Omega$ (typ.) @ $V_{GS} = 4.5 V$
- * Low capacitance
- * Optimized gate charge
- * Fast switching capability
- * Avalanche energy specified

■ SYMBOL

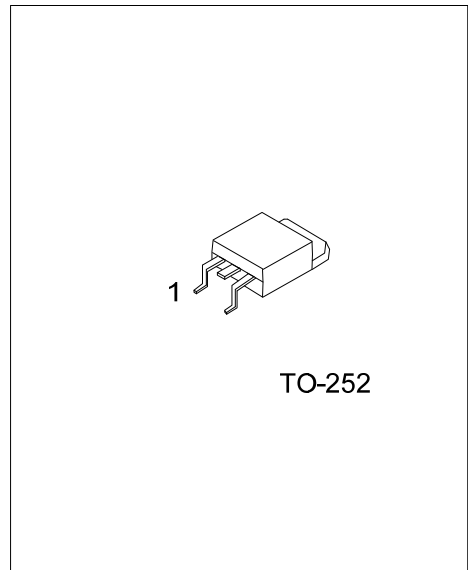
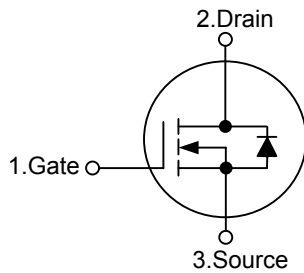

Lead-free: UTM2513L
Halogen-free: UTM2513G

■ ORDERING INFORMATION

Ordering Number			Package	Pin Assignment			Packing
Normal	Lead Free Plating	Halogen Free		1	2	3	
UTM2513-TN3-R	UTM2513L-TN3-R	UTM2513G-TN3-R	TO-252	G	D	S	Tape Reel
UTM2513-TN3-T	UTM2513L-TN3-T	UTM2513G-TN3-T	TO-252	G	D	S	Tube

<p>UTM2513L-TN3-R</p> <p>(1)Packing Type</p> <p>(2)Package Type</p> <p>(3)Lead Plating</p>	<p>(1) R: Tape Reel, T: Tube</p> <p>(2) TN3: TO-252</p> <p>(3) G: Halogen Free, L: Lead Free Plating, Blank: Pb/Sn</p>
--	--

■ ABSOLUTE MAXIMUM RATINGS ($T_A = 25^\circ\text{C}$, unless otherwise specified)

PARAMETER	SYMBOL	RATINGS	UNIT
Drain-Source Voltage	V_{DSS}	25	V
Gate-Source Voltage	V_{GSS}	± 20	V
Continuous Drain Current	I_D	40	A
Pulsed Drain Current	I_{DM}	90	A
Power Dissipation	P_D	50	W
Junction Temperature	T_J	150	$^\circ\text{C}$
Storage Temperature	T_{STG}	-55 ~ +150	$^\circ\text{C}$

Note: 1. Absolute maximum ratings are those values beyond which the device could be permanently damaged.

Absolute maximum ratings are stress ratings only and functional device operation is not implied.

2. Pulse width limited by $T_{J(MAX)}$

■ ELECTRICAL CHARACTERISTICS ($T_J = 25^\circ\text{C}$, unless otherwise noted)

PARAMETER	SYMBOL	TEST CONDITIONS	MIN	TYP	MAX	UNIT
OFF CHARACTERISTICS						
Drain-Source Breakdown Voltage	BV_{DSS}	$V_{GS}=0V, I_{DS}=250\mu A$	25			V
Drain-Source Leakage Current	I_{DSS}	$V_{DS}=24V, V_{GS}=0V$			1	μA
Gate-Source Leakage Current	I_{GSS}	$V_{DS}=0V, V_{GS}=\pm 20V$			± 100	nA
ON CHARACTERISTICS						
Gate Threshold Voltage	$V_{GS(TH)}$	$V_{DS}=V_{GS}, I_{DS}=250\mu A$	1.30	1.80	2.50	V
Drain-Source On-State Resistance(Note)	$R_{DS(ON)}$	$V_{GS}=10V, I_{DS}=12A$		10.5	13	m Ω
		$V_{GS}=4.5V, I_{DS}=10A$		16	23	
DYNAMIC CHARACTERISTICS						
Input Capacitance	C_{ISS}	$V_{DS}=15V, V_{GS}=0V, f=1.0MHz$		1560		pF
Output Capacitance	C_{OSS}			345		pF
Reverse Transfer Capacitance	C_{RSS}			245		pF
SWITCHING CHARACTERISTICS						
Turn-ON Delay Time (Note)	$t_{D(ON)}$	$I_{DS}=1A, V_{DD}=15V, R_G=3\Omega,$		30	35	ns
Turn-ON Rise Time	t_R			60	67	ns
Turn-OFF Delay Time	$t_{D(OFF)}$			272	285	ns
Turn-OFF Fall Time	t_F			168	172	ns
Total Gate Charge (Note)	Q_G	$V_{DS}=15V, V_{GS}=10V, I_{DS}=10A$		28	38	nC
Gate-Source Charge	Q_{GS}			3.6		nC
Gate-Drain Charge	Q_{GD}			8.4		nC
SOURCE- DRAIN DIODE RATINGS AND CHARACTERISTICS						
Drain-Source Diode Forward Voltage(Note)	V_{SD}	$I_{SD}=10A, V_{GS}=0V$		0.9	1.3	V

Note: Pulse width $\leq 300\mu s$, duty cycle $\leq 2\%$

TYPICAL CHARACTERISTICS

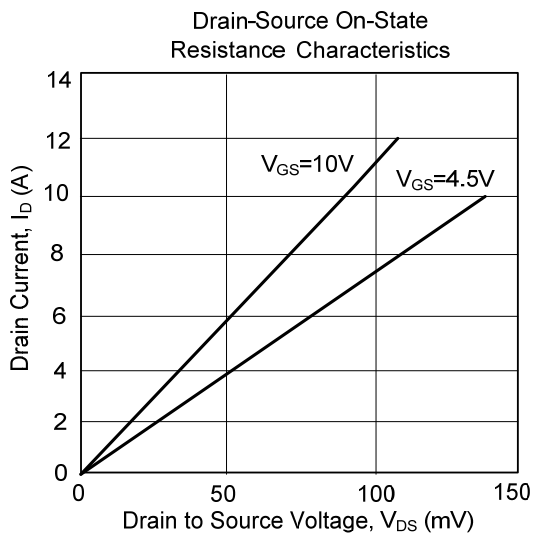
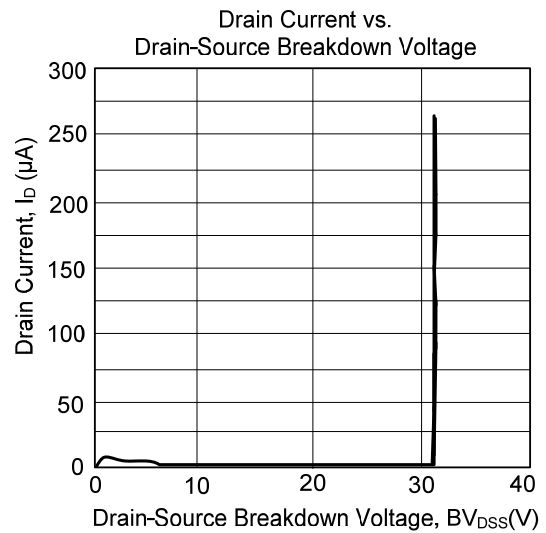
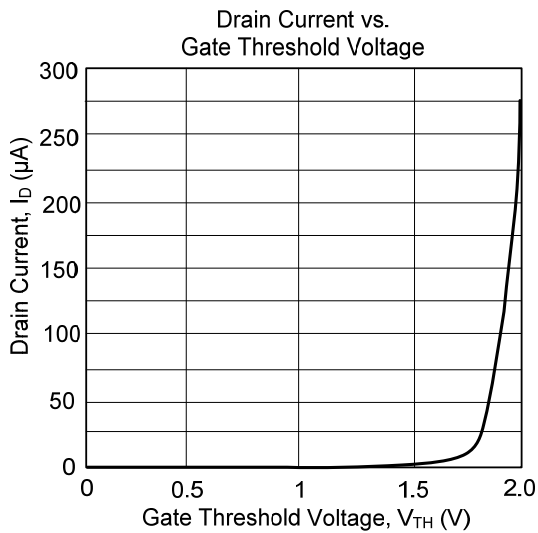
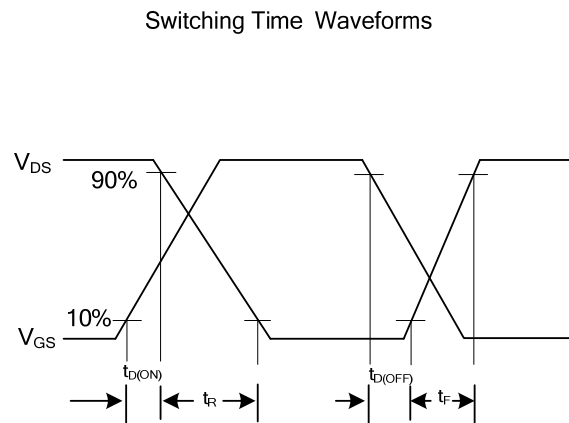
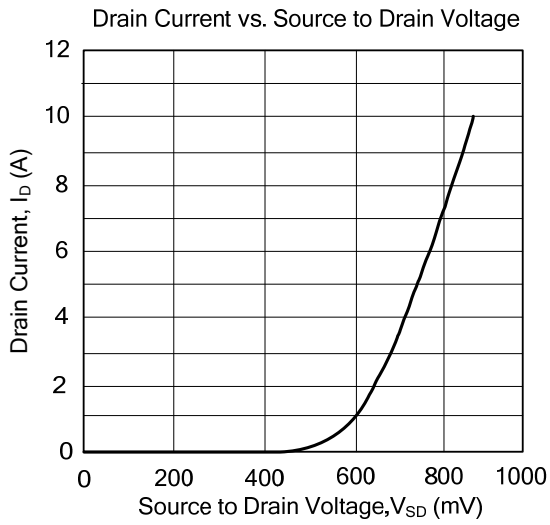

UTC assumes no responsibility for equipment failures that result from using products at values that exceed, even momentarily, rated values (such as maximum ratings, operating condition ranges, or other parameters) listed in products specifications of any and all UTC products described or contained herein. UTC products are not designed for use in life support appliances, devices or systems where malfunction of these products can be reasonably expected to result in personal injury. Reproduction in whole or in part is prohibited without the prior written consent of the copyright owner. The information presented in this document does not form part of any quotation or contract, is believed to be accurate and reliable and may be changed without notice.