



MPSA194

PNP SILICON TRANSISTOR

PNP EPITAXIAL SILICON TRANSISTOR

■ DESCRIPTION

The UTC **MPSA194** is designed for high voltage low power switching applications especially for use in telephone and telecommunication circuits.

■ FEATURES

- * Collector-Emitter Voltage: $V_{CEO}=400V$
- * Power Dissipation: 1.0W

■ APPLICATIONS

- * Telephone Circuit
- * Telecommunication Circuit

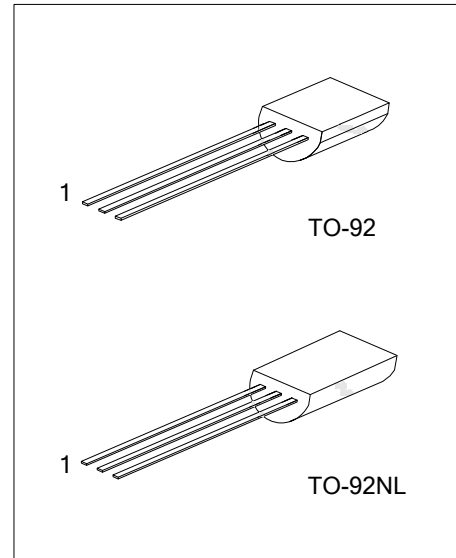

■ ORDERING INFORMATION

Ordering Number		Package	Pin Assignment			Packing
Lead Free	Halogen Free		1	2	3	
MPSA194L-T92-C-B	MPSA194G-T92-C-B	TO-92	E	B	C	Tape Box
MPSA194L-T92-C-K	MPSA194G-T92-C-K	TO-92	E	B	C	Bulk
MPSA194L-T92-A-B	MPSA194G-T92-A-B	TO-92	E	C	B	Tape Box
MPSA194L-T92-A-K	MPSA194G-T92-A-K	TO-92	E	C	B	Bulk
MPSA194L-T9N-B	MPSA194G-T9N-B	TO-92NL	E	C	B	Tape Box
MPSA194L-T9N-K	MPSA194G-T9N-K	TO-92NL	E	C	B	Bulk

Note: Pin assignment: B: Base C: Collector E: Emitter

<p>MPSA194G-T92-x-B</p>	<p>(1) B: Tape Box, K: Bulk (2) refer to Pin Assignment (3) T92: TO-92, T9N: TO-92NL (4) G: Halogen Free and Lead Free, L: Lead Free</p>
-------------------------	---

■ MARKING INFORMATION

TO-92	TO-92NL

■ ABSOLUTE MAXIMUM RATINGS

PARAMETER	SYMBOL	RATINGS	UNIT
Collector to Base Voltage	V_{CBO}	-400	V
Collector to Emitter Voltage	V_{CEO}	-400	V
Emitter to Base Voltage	V_{EBO}	-6	V
Collector Current	I_C	-800	mA
Collector Dissipation ($T_A=25^\circ\text{C}$)	P_C	1.0	W
Junction Temperature	T_J	+150	$^\circ\text{C}$
Storage Temperature	T_{STG}	-55 ~ +150	$^\circ\text{C}$

Note: Absolute maximum ratings are those values beyond which the device could be permanently damaged. Absolute maximum ratings are stress ratings only and functional device operation is not implied.

■ ELECTRICAL CHARACTERISTICS ($T_J=25^\circ\text{C}$, unless otherwise specified)

PARAMETER	SYMBOL	TEST CONDITIONS	MIN	TYP	MAX	UNIT
Collector-Base Breakdown Voltage	BV_{CBO}	$I_C = -100\mu\text{A}, I_E = 0\text{A}$	-400			V
Collector-Emitter Breakdown Voltage	BV_{CEO}	$I_C = -1\text{mA}, I_B = 0\text{A}$	-400			V
Collect Cut-off Current	I_{CBO}	$V_{CB} = -400\text{V}, I_E = 0\text{A}$			-10	μA
Collect Cut-off Current	I_{CEO}	$V_{CB} = -200\text{V}, V_{BE} = 0\text{V}$			-1	μA
Emitter Cut-off Current	I_{EBO}	$V_{EB} = -6\text{V}, I_C = 0\text{A}$			-0.2	μA
DC Current Gain	h_{FE}	$V_{CE} = -10\text{V}, I_C = -1\text{mA}$	50			
		$V_{CE} = -10\text{V}, I_C = -20\text{mA}$	50		800	
		$V_{CE} = -10\text{V}, I_C = -80\text{mA}$	40			
Base-Emitter Saturation Voltage	$V_{BE(SAT)}$	$I_C = -20\text{mA}, I_B = -2\text{mA}$			-0.9	V
Collector-Emitter Saturation Voltage	$V_{CE(SAT)}$	$I_C = -20\text{mA}, I_B = -4\text{mA}$			-0.2	V
		$I_C = -80\text{mA}, I_B = -2\text{mA}$			-1.2	V
Output Capacitance	C_{OB}	$V_{CB} = -20\text{V}, I_E = 0\text{A}, f = 1\text{MHz}$			30	pF
Current Gain Bandwidth Product	f_T	$V_{CE} = -20\text{V}, I_E = -10\text{A}, f = 1\text{MHz}$	10			MHz

TYPICAL CHARACTERISTICS

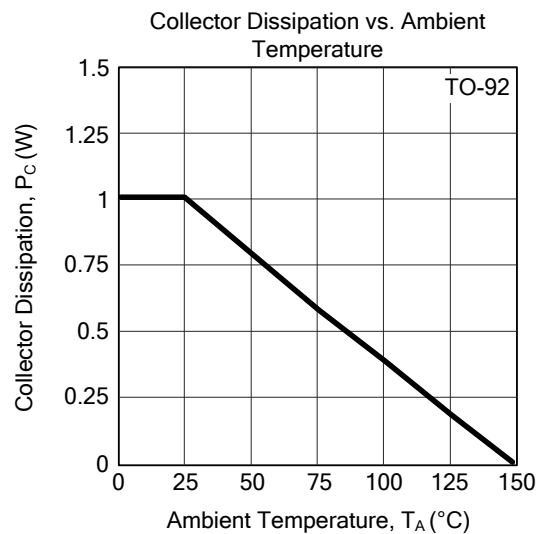
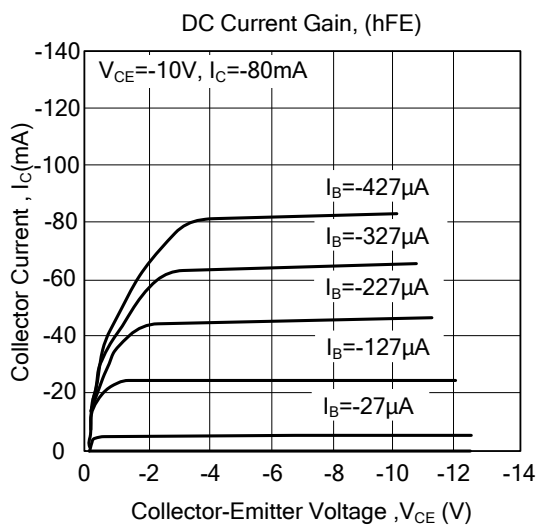
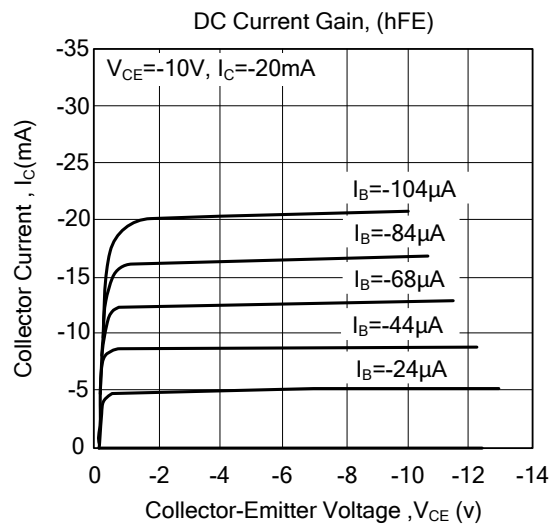
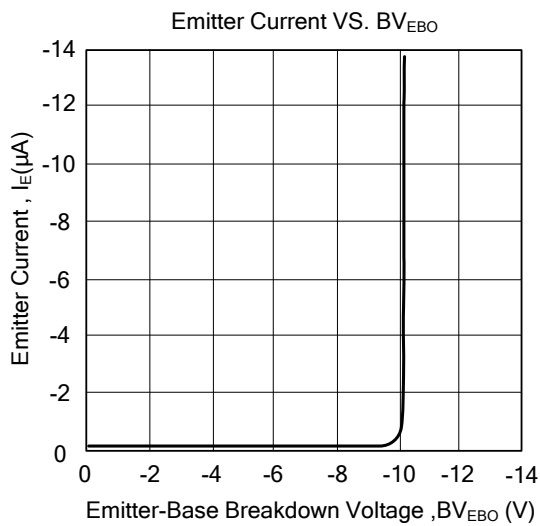
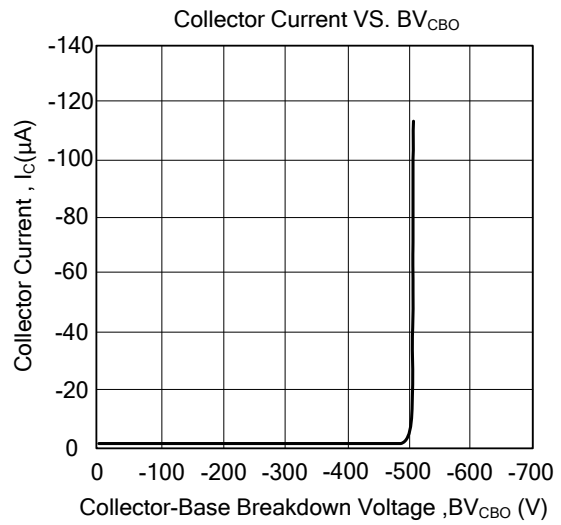
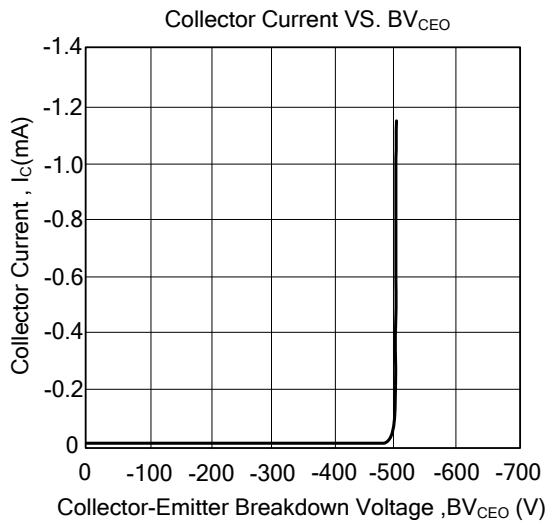

■ TYPICAL CHARACTERISTICS (Cont.)

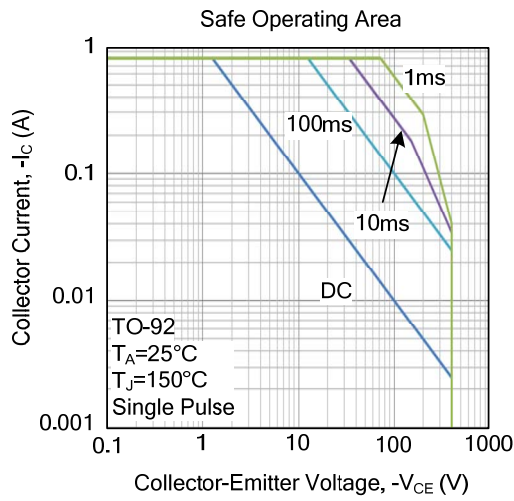

UTC assumes no responsibility for equipment failures that result from using products at values that exceed, even momentarily, rated values (such as maximum ratings, operating condition ranges, or other parameters) listed in products specifications of any and all UTC products described or contained herein. UTC products are not designed for use in life support appliances, devices or systems where malfunction of these products can be reasonably expected to result in personal injury. Reproduction in whole or in part is prohibited without the prior written consent of the copyright owner. UTC reserves the right to make changes to information published in this document, including without limitation specifications and product descriptions, at any time and without notice. This document supersedes and replaces all information supplied prior to the publication hereof.